

**VENTILCONVETTORI CANALIZZABILI AD ALTA PREVALENZA
STATICA UTILE (250Pa)
DUCTABLE HIGH STATIC PRESSURE FAN COIL UNITS (250Pa)
KANALISIERBARE GEBLÄSEKONVEKTOREINHEITEN MIT
HOHER STATISCHER PRÄVALENZ (250 Pa)**

Mod. PS-HDC PS-HDCE

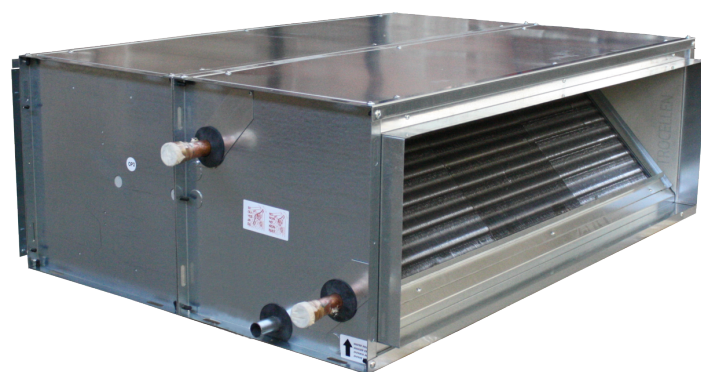

Scheda tecnica – Data sheet

 Made in Italy

CARATTERISTICHE GENERALI - DESCRIPTION – BESCHREIBUNG

L'unità canalizzabile modulare **PS-HDC** è particolarmente indicata per l'utilizzo in grandi impianti di climatizzazione centralizzati su strutture di tipo commerciale, magazzini da installare a soffitto con distribuzione dell'aria attraverso dei canali circolari o a plenum a sezione rettangolare. Unità caratterizzate da un'alta prevalenza tale da permettere un funzionamento dell'unità fino a 250 Pa.

Questi terminali si presentano nella versione 2 o 4 tubi

The modular ductable fan coil unit mod. **PS-HDC** is particularly indicated for the installation in the centralized air-conditioning system, by some commercial malls or big warehouses to be installed recessed into the ceiling by means of a circular ducts system or a plenum with rectangular section. Units characterized by a high static pressure that allows the unit to operate up to 250 Pa.

These units can be supplied with 2 or 4 pipes

Die modulare kanalisierbare Gebläsekonvektoreinheit mod. **PS-HDC** ist besonders für die Installation in der zentralen Klimaanlage geeignet, indem einige Einkaufszentren oder große Lagerhäuser mit Luftleitung durch runde Kanäle oder Plenum in die Decke eingelassen werden. Diese Geräte sind gekennzeichnet durch einen hohen statischen Druck und einen Betrieb von bis zu 250 Pa ermöglichen. Sie können mit 2 oder 4 Rohren geliefert werden.

CARATTERISTICHE COSTRUTTIVE - CONSTRUCTION FEATURES - EIGENSCHAFTEN

Struttura realizzata in robusta lamiera zincata, isolata internamente con materiale anticondensa e fonoassorbente.

Scambiatore a batteria piana composta da pacco alettato in alluminio con tubi e collettori in rame provvisti di attacchi filettati da 1 ½" gas femmina (con sfiato aria); disponibile con 2 o 4 attacchi. Lato standard per l'attacco acqua: destra. Al momento dell'ordine è possibile chiedere di posizionarlo sul lato sinistro.

Ventilatore di tipo centrifugo a doppia aspirazione con coclee e ventole in lamiera zincata equilibrato dinamicamente e staticamente.

Motore ad induzione monofase AC a 3 velocità (mod. PS-HDC) oppure monofase EC con inverter (mod. PS-HDCE) montato su supporti antivibranti.

Filtro aria di tipo sintetico lavabile piano tipo G3 (optional ondulato G4), facilmente estraibile per le operazioni di manutenzione con l'utilizzo del tronchetto portafiltro.

Frame made of strong galvanized plate, internally insulated with anti-condensation coating and sound-absorbing material.

Exchanger made of plane coil composed by finned in aluminium with copper pipes and collectors provided with 1" ½ female threaded connections (with air bleed); available with 2 or 4 connections. Standard water connection side: right. When ordering, you can ask to place then on the left side.

Fan of centrifugal double intake type. Augers and fan with galvanized structure and impeller dynamically and statically balanced.

Motor Induction single phase AC type with 3 speed (mod. PS-HDC) or single phase EC with Inverter mounted on antivibration supports (mod. PS-HDCE).

Air filter washable synthetic flat filter G3 type (on request the corrugated G4 type is available), easily removable for maintenance operations when installing the filter holder socket.

Das Gehäuse ist aus festem verzinktem Blech, das mit schallschluckender und Kondensatschutzmaterial isoliert wird. Auf Anfrage kann man Aluzink-Blech verwenden für den Einsatz in korrosiven Umgebungen.

Wärmeaustauscher mit flacher Batterie aus hydrophilen Aluminiumlamellen und Kupferrohren zusammengesetzt mit Gewindeanschlüssen 1 1/2" weibliches Gas vorgesehen (mit Entlüfter); erhältlich mit 2 oder 4 Wasseranschlüssen; Standardseite für Wasseranschluss: rechts. Bei der Bestellung können Sie darum bitten, sie auf der linken Seite zu platzieren.

Lüfter mit Doppelansaugung und Wendel aus verzinktem Blech; ABS Flügelräder; statisch und dynamisch Ausgewuchtet.

Einphasen Induktionsmotor AC mit 3 Geschwindigkeiten (Mod. HDC) oder EC mit Inverter (Mod. PS-HDCE) und auf Schwingungsdämpfer montiert

Syntetische, waschbare **Luftfilter** G3 Type (zur Anfrage gewellter Filter G4), einfach in der Wartung mit der Filterhalterdüse

DATI TECNICI UNITA' VERSIONE AC- TECHNICAL DETAILS AC VERSION

PS-HDC		250/4R	370/4R	400/4R	570/4R	690/4R
Capacità totale freddo ¹ Total cooling capacity	KW (max)	16,70	31,05	34,34	41,91	47,82
	KW (med)	15,83	29,62	32,83	39,85	45,42
	KW (min)	14,95	27,79	31,15	37,80	43,02
Capacità sensibile freddo ¹ Sensible cooling capacity	KW (max)	10,56	19,54	21,63	26,37	30,23
	KW (med)	10,02	18,64	20,80	25,08	28,66
	KW (min)	9,47	17,51	19,65	23,80	27,17
Portata acqua ¹ Water flow	l/h (max)	2866	5328	5892	7191	8205
Perdita di carico ¹ Pressure drop	kPa	26	22	29	27	32
Capacità caldo ² Heating capacity	KW (max)	18,92	35,86	39,47	48,41	55,62
	KW (med)	17,85	34,01	37,69	45,83	52,44
	KW (min)	16,75	31,73	35,44	43,15	49,45
Portata acqua ² Water flow	l/h (max)	2866	5328	5892	7191	8205
Perdita di carico ² Pressure drop	kPa	24	19	25	22	25
Portata aria Air flow	m ³ /h(max)	2170	4325	4700	5860	6780
	m ³ /h(med)	2025	4050	4440	5470	6300
	m ³ /h (min)	1880	3720	4120	5080	5855
Livello pressione sonora Sound pressure level	dB(A)(max)	53	52	54	55	53
Alimentazione Power supply	V/Ph/Hz	210-230/1/ 50-60				
Potenza assorbita Absorbed power	W (max)	420	770	860	970	1220
Corrente assorbita Absorbed current	A (max)	2,06	4,06	4,16	3,49	5,56
Connes. idriche senza valvola Water connect. without valve.	Nr. x "	2 x 1" F	2 x 1 ½" F			
Connes. idriche con valvola Water connect. with valve	Nr. x "	2 x 1" M	2 x 1 ¼" M			
Dimensioni unità Unit dimensions	mm (L-P-H)	1000x880x420	1400x880x420	1600x880x420	1800x880x420	2000x880x420
Peso totale/Total weight	Kg	88	96	106	135	176

DATI TECNICI UNITA' VERSIONE EC- TECHNICAL DETAILS EC VERSION

PS-HDCE		250/4R	370/4R	400/4R	570/4R	690/4R
Capacità totale freddo ¹ Total cooling capacity	KW (10V)	18,43	31,05	34,34	41,91	47,82
	KW (6V)	13,89	23,29	26,89	31,21	36,08
	KW (2V)	7,53	11,23	13,25	16,49	20,00
Capacità sensibile freddo ¹ Sensible cooling capacity	KW (10V)	11,61	19,54	21,63	26,37	30,23
	KW (6V)	8,74	14,71	17,01	19,69	23,03
	KW (2V)	4,77	7,11	8,39	10,49	12,80
Portata acqua ¹ Water flow	l/h (10V)	3162	5328	5892	7191	8205
Perdita di carico ¹ Pressure drop	kPa	26	22	29	27	32
Capacità caldo ² Heating capacity	KW (10V)	21,03	35,86	39,47	48,41	55,62
	KW (6V)	15,36	26,13	30,17	34,99	40,94
	KW (2V)	7,91	11,78	13,94	17,51	21,52
Portata acqua ² Water flow	l/h (10V)	3162	5328	5892	7191	8205
Perdita di carico ² Pressure drop	kPa	24	19	25	22	25
Portata aria Air flow	m ³ /h(10V)	2465	4325	4700	5860	6780
	m ³ /h(6V)	1700	2950	3400	3950	4665
	m ³ /h (2V)	820	1220	1445	1825	2260
Livello pressione sonora Sound pressure level	dB(A)(10V)	51	50	52	53	51
Alimentazione Power supply	V/Ph/Hz	210-230/1/ 50-60				
Potenza assorbita Absorbed power	W (10V)	300	720	670	1120	1060
Corrente assorbita Absorbed current	A (10V)	1,30	3,13	2,90	4,75	4,60
Connes. idriche senza valvola Water connect. without valve.	Nr. x "	2 x 1" F	2 x 1 ½" F			
Connes. idriche con valvola Water connect. with valve	Nr. x "	2 x 1" M	2 x 1 ¼" M			
Dimensioni unità Unit dimensions	mm (L-P-H)	1000x880x420	1400x880x420	1600x880x420	1800x880x420	2000x880x420
Peso totale/Total weight	Kg	88	96	106	135	176

*The data shown above in the table may differ slightly from the detailed technical selection of the product.

I dati sopra riportati in tabella possono differire leggermente dalla selezione tecnica dettagliata del prodotto

Reference conditions:

- 1: water temperature 7/12°C, air temperature 27°C b.s. - 19°C b.u.
- 3: sound pressure level measured in closed room with 0,4s reverberation time, distanza.

Functioning limits:

- max temperature IN water 80°C;
- max working water pressure 10 bar.

Condizioni di riferimento:

- 1- temperatura acqua 7/12° C, temperatura aria 27° C b.s. - 19° C b.u.
- 3- livello di pressione sonora misurata in ambiente chiuso con tempo di riverberazione pari a 0,4s, a 1 m di distanza







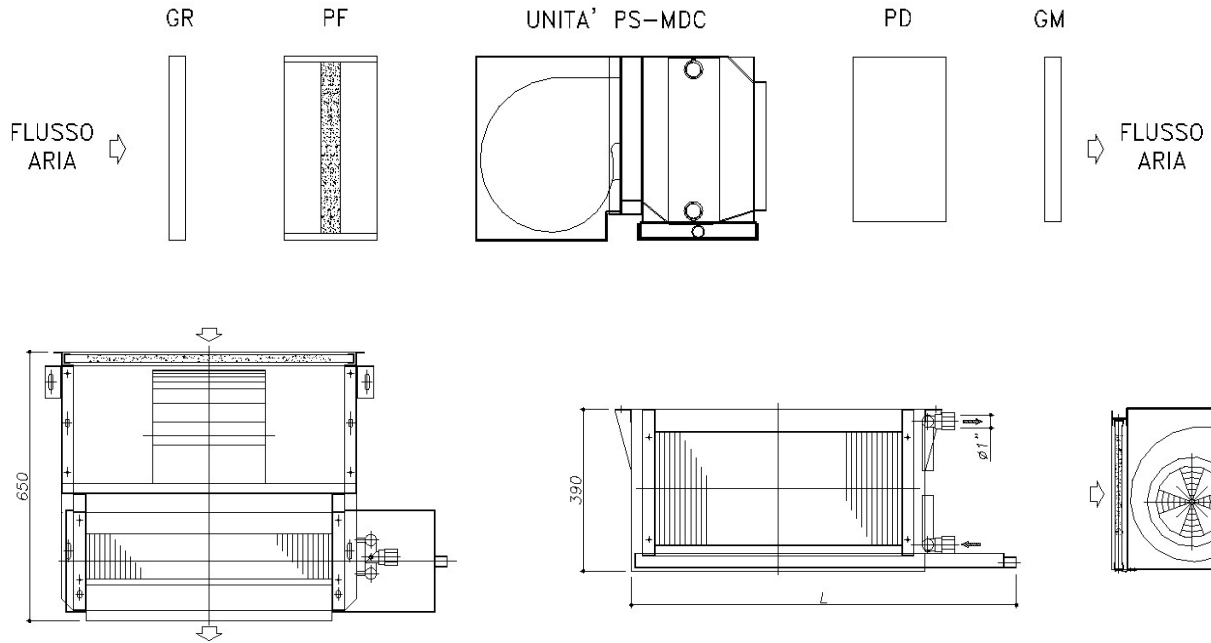

Limiti di funzionamento:









- temperatura massima acqua IN 80°C
- massima pressione di esercizio 10 bar.

DIMENSIONI UNITA' - UNIT DIMENSIONS



ACCESSORI - OPTIONS – ZUBEHOER

	TER.ANA	Termostato a muro analogico Wall analogic thermostat
	TER.DIG	Termostato a muro con display digitale Wall thermostat with display
	TER.DIG.D	Termostato a muro con display digitale più grande adatto solo per unità AC Wall thermostat with bigger screen suitable for the AC unit only
	TER.BUS	Termostato a muro per sistema di supervisione BMS Wall thermostat for BMS supervision system
	TER.TOUCH	Termostato con display "Touch screen" - valido solo per versione a 2 tubi Touch screen thermostat- valid only for 2 pipes version
	TER.TOUCH.EC	Termostato con display "Touch screen" per motori EC-valido solo per versione a 2 tubi con funzione WI-FI Touch screen thermostat suitable for the EC versions - valid only for 2 pipes version with WI-FI function
	TER.EC.DIG	Termostato a muro per motoventilatori EC con display idoneo alla funzione di change over con aggiunta accessorio SM. Wall thermostat for EC motor-fan control with display suitable for change over function with addition of SM accessory.
	TER.EC.ANA	Termostato a muro per comando motoventilatori EC Wall thermostat for EC motor-fan control

	KIT.TEL.EC	Kit telecomando x versioni EC (SOLO scheda + ricevitore) Infrared remote control kit suitable for EC versions (ONLY PCB + receiver)
	IDP	Interfaccia di potenza (4 unità con 1 termostato) Power interface (4 units with 1 thermostat)
	VAL.114.DIN	Valvola di bilanciamento a 2 vie 11/4" montata (da abbinare con attuatore) Installed 2-way balancing valve 11/4" (to be coupled to the actuator)
	VAL.SFE.10	Kit valvole a sfera F-F 1" (2 pz.) smontata Ball valve kit 1" F-F (2 pcs) not installed
	VAL.2V.S.114.HDC VAL.3V.S.114.HDC	Valvola 2 o 3 vie sfera 11/4" montata (abbinare con attuatore) Installed 2 or 3-way valve 11/4" (to be coupled to the actuator)
	EST.114	Kit tubi estensibili inox 11/4" M-F (2 pz.) Inox extensible tubes kit 11/4" M-F (2 pcs)
	PLE.CIR	Plenum connessione circolare Plenum with spigots
	PLE.RID	Plenum di attenuazione su aspirazione e scarico dell'aria Air-intake and air discharge sound attenuation plenum
	GRF-V	Verniciatura griglia di aspirazione con colorazione RAL a richiesta Different RAL colour for the air intake grille on demand

A decorative graphic consisting of several overlapping, wavy, translucent blue lines that flow across the middle of the page, creating a sense of movement and depth.

PST Clima Srl - Via Pietro Candiano, 8 - 36016 Thiene (VI) ITALY
+39 0445-540348 - export@pstclima.it – vendite@pstclima.it -
www.pstclima.it