

# 1 DESCRIPTION

The OCDS008 digital chronothermostat integrates the functions of room temperature control and remote control of the heating system with Robur gas unit heaters in a single interface, specially designed to make all functions available to the user in a clear and intuitive way.

The remote control of the heating system allows managing the operating parameters and unlocking of more gas unit heaters with the relative OTRG005 thermoregulators connected in cascade.

The weekly programming includes 3 adjustable temperature

levels and daily time slots composed of 15' individual intervals, which can be displayed on the appropriate graph of the daily program.

The communication between the chronothermostat (which act as master) and the thermoregulators (slave) of the gas unit heaters is carried out by means of a two-wire unpolarised cable.

In detail, between the chronothermostat and the thermoregulator of the first gas unit heater of the cascade, the data are exchanged with an OpenTherm compatible communication protocol.

# 2 FEATURES

- ▶ Graphic LCD 128x64 dots
- ▶ Backlight timer 20 s
- ▶ Diagnostic/signaling LED
- ▶ 7 variable function buttons
- ▶ Weekly programming
- ▶ 3 temperature levels (T1, T2, T3)
- ▶ Adjustable room temperature resolution: 0,5 °C
- ▶ Measured room temperature resolution: 0,1 °C
- ▶ Minimum programming interval: 15 minutes
- ▶ SELV (Safety Extra Low Voltage) insulation
- ▶ Simple connection (non-polarised) to OTRG005 thermoregulator, with two-wire cable

# 3 TECHNICAL CHARACTERISTICS

Table 3.1 Technical characteristics

		Chronothermostat	
Operating temperature	minimum	°C	0
	maximum	°C	50
Humidity	maximum at 40 °C	%	95
Power supply	voltage	V	3 <sup>(1)</sup>
Degree of protection	IP	-	30
Dimensions	width	mm	140
	height	mm	90
	depth	mm	32

(1) Value obtained from communication with the OTRG005 thermoregulator.



The OCDS008 digital chronothermostat complies with the Electromagnetic Compatibility Directive (2014/30/EC) and the Low Voltage Directive (2014/35/EC).

Figure 3.1 Dimensions

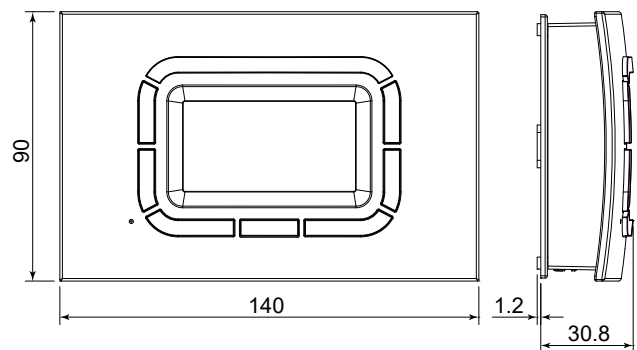
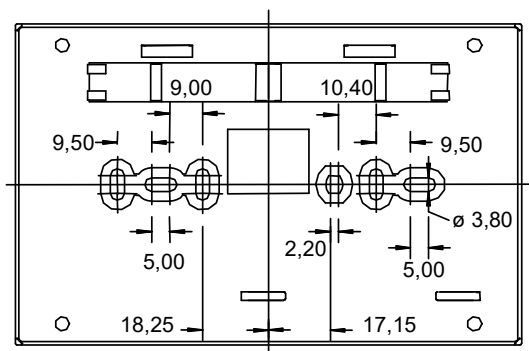

Figure 3.2 Fixing holes position



# 4 OPERATING INSTRUCTIONS

To visualize the parameters and interact with the heating system, the chronothermostat offers the user a graphic LCD dot matrix display and a series of silicon rubber buttons, as well as a transparent button that act as a window for a signal LED. The vertical buttons to the left of the display (detail F Figure

4.1 p. 2) are used to navigate through the setting menus or to select parameters to interact with.

The vertical buttons to the right of the display (detail C Figure 4.1 p. 2) allow the parameters and temperatures to be changed with the increase/decrease function (+/-).

To facilitate the change of set values, long pressure on these buttons accelerates the increase or decrease.

The horizontal buttons at the bottom (detail D Figure 4.1 p. 2) are used, in most cases, to confirm or cancel the settings or to enter and exit the various menus.

The transparent central button (detail B Figure 4.1 p. 2), for which specific functions are reserved, such as the fault unlocking, signals:

- ▶ With red light (flashing): that one or more gas unit heaters are in lockout.
- ▶ With green light (which can remain on also for several seconds): that the chronothermostat is restarting after a power failure.

**Figure 4.1** Control description

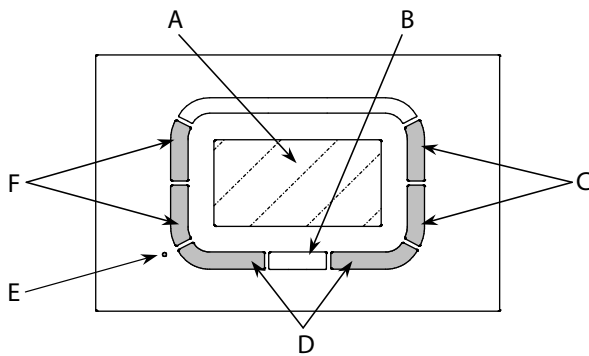

- A LCD graphic display
- B Transparent multifunction button with led
- C Function buttons (increase and decrease of temperature and parameters)
- D Function buttons (the corresponding command is shown on the display)
- E Hole for access to the reset button
- F Function buttons (function and parameter selection)

The functions most frequently used by the user are easily available in the main or first level menu (Paragraph 4.3 p. 2), where you can quickly browse through the various pages to set, for example, the room temperature control or the maximum/reduced power provided by the gas unit heaters.

### 4.1 LANGUAGE SETTING

When the chronothermostat is switched on for the first time or after a reset, the language selection menu appears, as shown in Figure 4.2 p. 2.

F buttons allow selection while OK button confirms the choice. If you press ESC, the next time you reconnect the chronothermostat (for example, due to a power failure), you will be prompted to set the language again.

This choice can be changed later, if necessary, via the "Setting menu".

Languages available are English, Italian, French, German, Russian and Dutch.

**Figure 4.2** Language setting



### 4.2 TIME SETTING

The F buttons are used to select the various menu items, while the C buttons are used to change their value; the OK button stores the settings while the ESC button allows you to continue without changing the time data.

If you press ESC, the next time you reconnect the chronothermostat (for example, due to a power failure), you will be prompted to set the current time again.

**Figure 4.3** Time setting

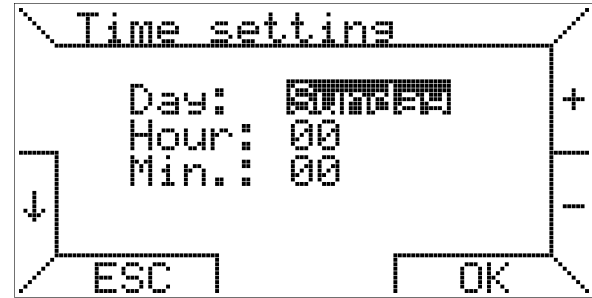

### 4.3 FIRST LEVEL MENU

When the chronothermostat is connected to a gas unit heater equipped with its OTRG005 thermoregulator, the display appears as in Figure 4.4 p. 2.

**Figure 4.4** Main page

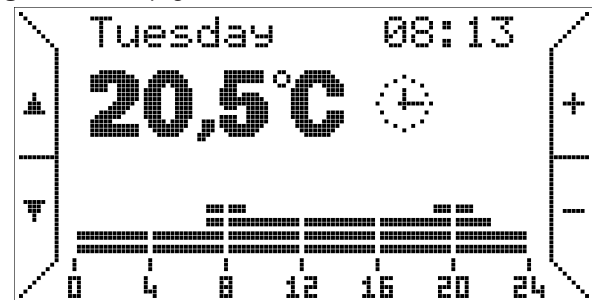

If the gas unit heater control unit is incompatible, an error message will be displayed.

At the top of the main screen the day of the week and the current time are shown; these indications are intermittent if they are to be updated (e.g. if you pressed ESC in the initial time setting screen).

The lower part shows the room temperature measured by the onboard probe (the measurement takes place every 10 seconds); next to it, an icon indicates the currently active temperature control function: in Figure 4.4 p. 2 the icon indicates automatic operation.

Table 4.1 p. 3 shows the correspondence between icons and operating modes.

**Table 4.1** Correspondence between icons and operating modes

Icon	Operation	Description
	Automatic	Thermoregulation according to the weekly program set by the user. Current day program shown as a graph.
	Manual	Room temperature control according to a user-selected temperature (thermostatic function).
	Summer	Room heating disabled. Summer ventilation can be activated manually or by following the time slot on the display.
	Standby	Temperature control and ventilation functions disabled.
	Overtime	Room temperature control according to a user-selected temperature (thermostatic function), for a user-selected duration. <sup>(1)</sup>

(1) After the time set for the overtime mode, the chronothermostat always switches to the automatic mode.

In automatic mode, the chronothermostat performs the temperature control program set for the current day, the graph of which is visible at the bottom of the display.

This graph is divided into 15 minutes time slots, corresponding to one pixel horizontally, and into three programmable temperature levels, while the last one corresponds to off.

In certain conditions, an additional heating system icon appears next to the operating mode icon, indicating that the burner is on (flame symbol of different sizes depending on the power level ), or that a lockout (), or a fault (), or a communication error () is present.

No icon appears in Figure 4.4 p. 2 screen, so the system is in standby (no heating request) and there is no fault.

Under the room temperature reading, there may also be a text line that provides information to the user in particular cases, such as locking or error (Table 4.2 p. 3).

**Table 4.2** Errors

Error	Meaning
Starting...	The chronothermostat is being connected to the thermoregulator of the gas unit heater.
Comm. Error	Communication error between the chronothermostat and the thermoregulator of the gas unit heater.
Fault code xxx Slave number x	Presence of a fault or an error in the system. Fault code XXX in slave number X.
Room probe fault	Room temperature probe reading error. Possible internal room temperature probe fault.
Outdoor probe error	Outdoor temperature probe reading error. This version of the OCDS008 digital chronothermostat is not enabled for operation with an outdoor probe.

Buttons C, marked with + and -, allow in this case to change the programmed temperature for the automatic programme (T1, T2, T3), while in the manual operation mode (icon ) the corresponding temperature is changed.

Press the F buttons, marked with the arrows, you can browse the pages of the first level menu.

By pressing the button, for example, the screen in Figure 4.5 p. 3 appears, where you can select the "Manual mode" (thermostatic function).

**Figure 4.5** "Manual mode" selection

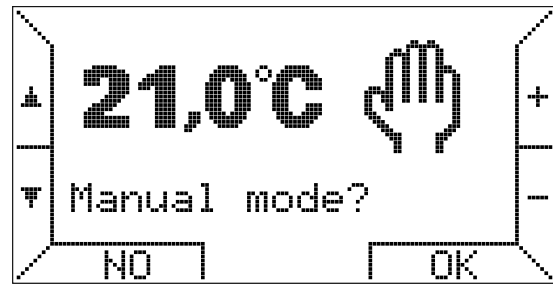

Press the +/- buttons to change the temperature and press the button corresponding to OK to activate the manual mode. Pressing the button again enables operation in "Summer mode", thus disabling room temperature control (Figure 4.6 p. 3).

**Figure 4.6** "Summer mode" selection

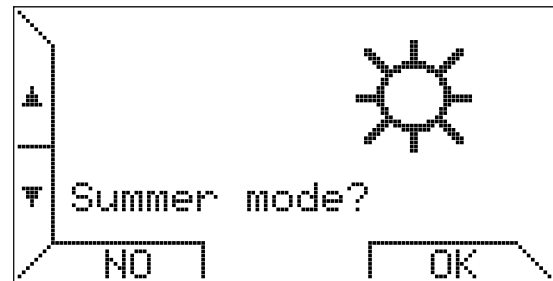

If "Summer mode" is selected, summer ventilation works by following the time slot of the set weekly programme in the automatic mode described above.

In particular, if the current time displayed is within the off time, ventilation is turned off. If, on the other hand, the time is within the time slot in which T1, T2 or T3 temperatures are set, the ventilation is switched on.

Summer ventilation activation is indicated by the icon; the time slots are instead displayed in the graph at the bottom of the screen as shown in Figure 4.7 p. 3.

**Figure 4.7** Automatic summer ventilation mode

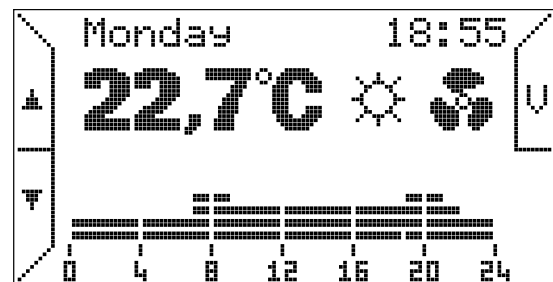

If necessary, it is possible to force the summer ventilation by means of the V special key, located at the top right. Once the ventilation forced, the V button is highlighted, the display shows the message "Forced cooling" and the time slots display disappears, as shown in Figure 4.8 p. 4.

**Figure 4.8** Forced summer ventilation mode



Pressing the ▼ button again switches to the standby mode selection (Figure 4.9 p. 4).

**Figure 4.9** Standby mode selection

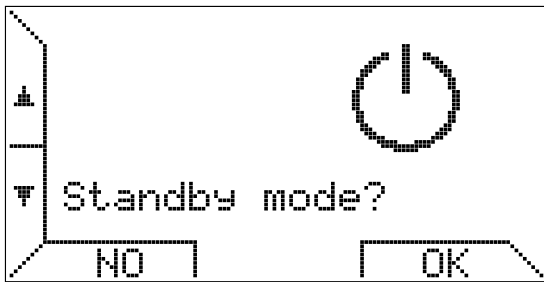

Pressing the ▼ arrow again you can choose to activate the overtime operation mode (Figure 4.10 p. 4).

**Figure 4.10** "Overtime mode" selection

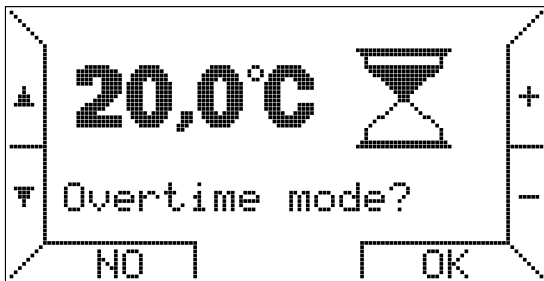

In this operating mode, the room temperature is controlled by following a temperature set by the user for a period also set by the user.

The duration of each step is 15 minutes, the maximum duration is 240 minutes.

Press the +/- buttons to set the temperature and then after pressing the OK button you are prompted to set the duration as in the example of Figure 4.11 p. 4.

**Figure 4.11** "Overtime mode" duration setting

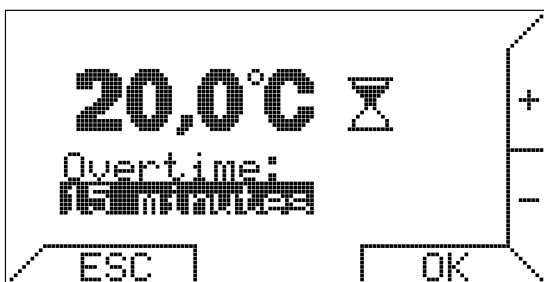

Once the duration of the overtime function has elapsed, the chronothermostat switches to the automatic operation mode. The overtime operation mode is useful when you want to interrupt the automatic operation mode by forcing a specific temperature for a specific period of time.

All the screens described so far and the following ones are accessible also by pressing the ▼ button; in this case, being the first level menu circular, the order of selection of the screens will be inverted.

Pressing the ▼ button again will bring up the "Setting menu" (Figure 4.12 p. 4).

**Figure 4.12** "Setting menu" selection

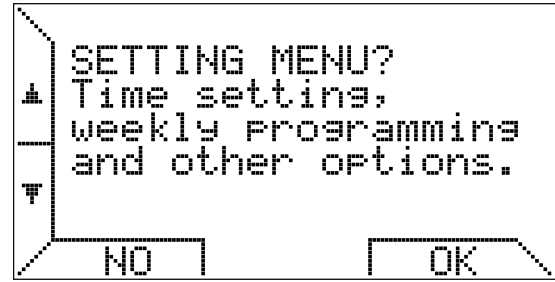

This menu, described in Paragraph 4.4 p. 5, is dedicated to the local parameters of the chronothermostat, such as current time, temperatures and weekly program.

Pressing the ▼ button again you can set the maximum power with which is possible to limit the power level required by the chronothermostat to the gas unit heater for room heating, if they are designed for this kind of control (Figure 4.13 p. 4).



By setting any value other than 100%, the Next-R gas unit heater will only run at minimum power.

For additional details see Paragraph 4.4.3 p. 7.

**Figure 4.13** Limiting maximum power

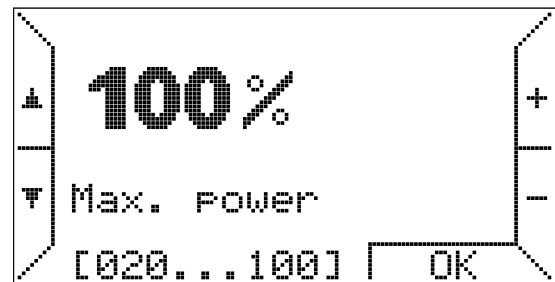

The next screen, however, proposes to enter the "Parameters menu".

**Figure 4.14** "Parameters menu" selection

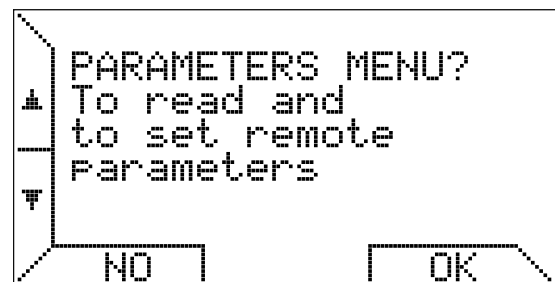

This menu, described in Paragraph 4.5 p. 7, allows consulting in depth the gas unit heater parameters and allows the access to advanced functions, such as the management of the "transparent parameters" (TSP) and the unlocking.

If you do not enter the menu and press the ▼ button again, the heating system control panel is shown (Figure 4.15 p. 5).

Figure 4.15 Heating system control panel

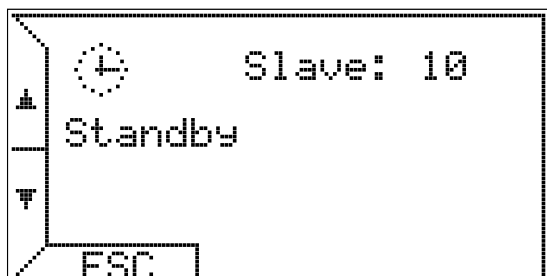

The first line shows the icons with the thermoregulation status and the gas unit heaters status and, on the side, the number of gas unit heaters (namely of the thermoregulators) connected; in the central part additional information on the gas unit heaters status or on any faults are provided; in the third line any errors related to the room temperature control are shown.

Unlike the other menu pages, this one has a frame because it's a fixed display.

The options shown above, in fact, remain waiting for a user choice for 20 seconds, after which the display returns to a normal display that depends only on the chosen temperature control mode (manual, auto, summer, off, overtime).

In this case, however, until the user presses ESC or changes the menu page with ▲ and ▼ buttons, the chronothermostat continues to show the control panel with the relevant information. The last page of the menu, which is always accessed with the ▼ button, proposes the activation of the "Auto mode".

Figure 4.16 "Auto mode" selection

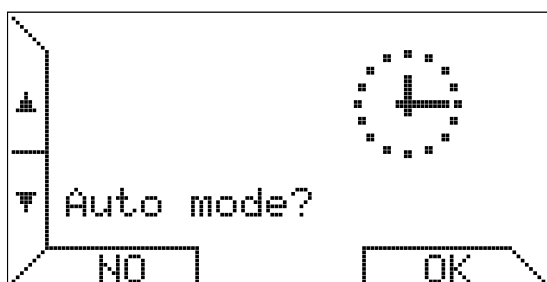

If the "Auto mode" is already active, pressing NO or OK makes no difference.

## 4.4 CHRONOTHERMOSTAT OPERATION - SETTING MENU

### 4.4.1 Programming menu

This menu allows managing the room temperature control, including the weekly program performed by the chronothermostat.

Figure 4.17 "Setting menu"

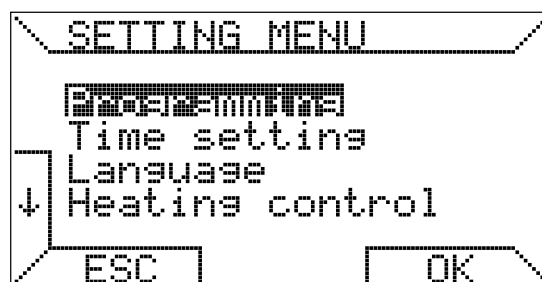

By choosing the item "Programming" and pressing the OK button, you enter another menu dedicated to the weekly program. By selecting the "Temperatures" item, you enter the T1, T2 and T3 setting screen (Figures 4.18 p. 5 and 4.19 p. 5).

Figure 4.18 "Programming" menu

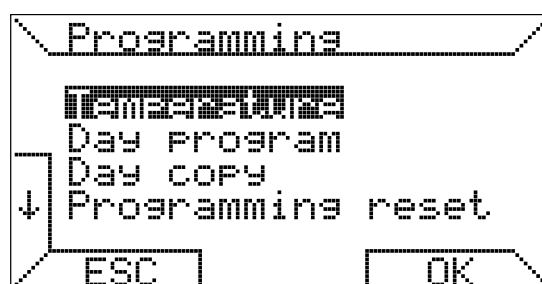
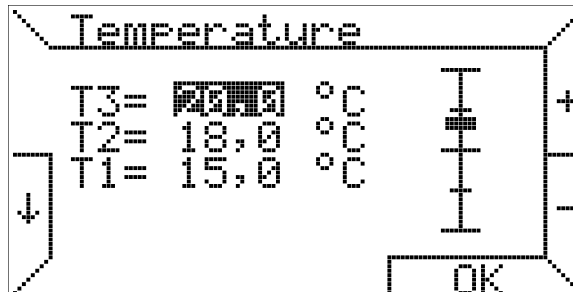

Figure 4.19 "Temperature" setting



To select the temperature that you want to change, move through the display with the ▲ and ▼ buttons, while the + and - buttons allow you to change its value. A graduated bar on the right shows the relative position of the current value with respect to the minimum and maximum values that room temperature setpoint can assume.

In particular, the value of T1 can be set between 3 °C and 25 °C, while T2 and T3 can be set between 10 °C and 30 °C. The step is always 0,5 °C.

In addition, to comply with the programming logic that involves associating the highest temperature T3 and the lowest temperature T1, the chronothermostat complies with the following constraint: "T1 ≤ T2 ≤ T3", and resizes automatically all the temperatures set by the user accordingly.

If you select the item "Day program" in the "Programming" menu, the screen shown in Figure 4.20 p. 6 appears.

Figure 4.20 "Day program" menu

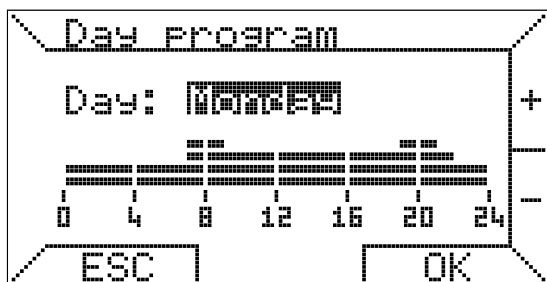

The day to be programmed is highlighted and can be changed with + and - buttons, while the corresponding daily programme is shown below as a reminder.

Supposing you want to program "Monday", by pressing OK you can enter the programming of the time slots.

The time slots are programmed in three steps: start, desired temperature and end.

In the first step, enter the start time, using the + and - buttons, at intervals of at least 15 minutes, and confirm with OK (Figure 4.21 p. 6).

Figure 4.21 "Starting time" setting

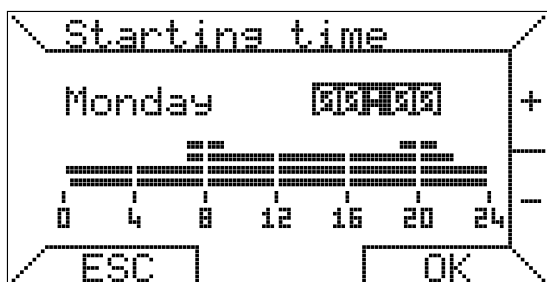

If, instead, you want to leave the programming of the selected day and change the day, simply press ESC.

Select then the programmed temperature to be associated with this slot, moving on the display with the ► and ◀ buttons to select and pressing OK to confirm or ESC to change the slot starting time (Figure 4.22 p. 6).

Figure 4.22 Time slot "Temperature" setting

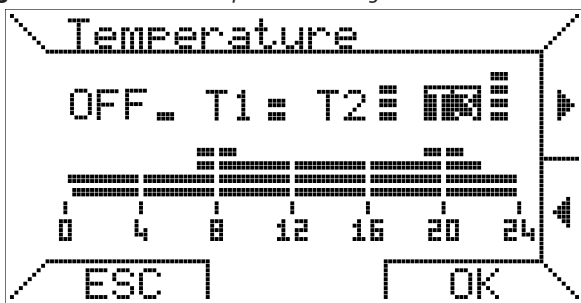

In the last step, enter the end of the time period and confirm with OK (Figure 4.23 p. 6).

This time cannot be less than the start time of the time period; if you select the same value for the start and the end of the time period, the daily programme is not changed.

Figure 4.23 "Ending time" setting

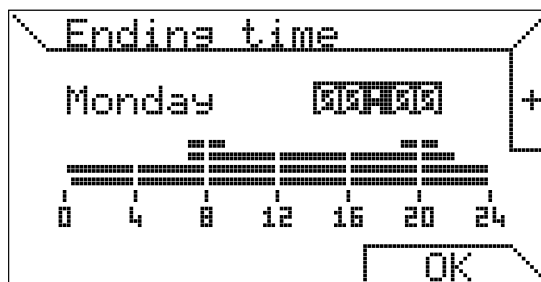

The third item of the "Programming" menu allows you to copy the program from one day to another (Figure 4.24 p. 6).

Figure 4.24 "Day copy" function

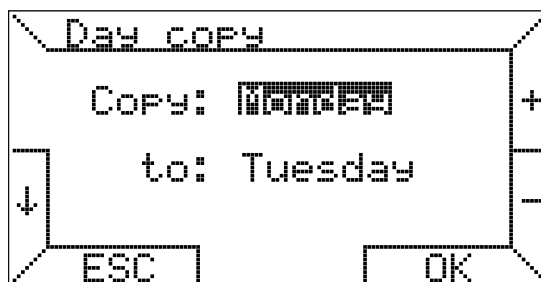

Select the source day at the top ("Copy") and the target day at the bottom ("to"); you can copy an already programmed day to the whole week to have the same program every day: to do this simply select as the target the item "ALL". When the OK button is pressed, a message confirms that the program has been copied. The last item of the "Programming" menu, called "Programming reset", allows you instead to load the default weekly program and the three default temperatures (T1, T2, T3) quickly (Figure 4.25 p. 6).

Figure 4.25 Program "Reset" function

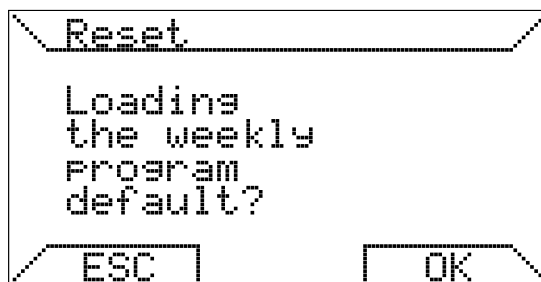

#### 4.4.2 Time setting menu

The second item of the "Setting menu" allows the setting of the day of the week and the current time (Figure 4.26 p. 7).



Figure 4.26 Time setting

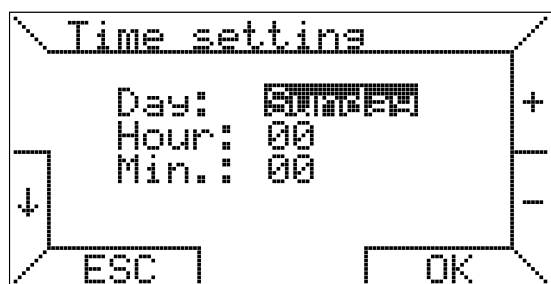

As with other menu pages already described, the selection is made with the buttons  $\uparrow$  and  $\downarrow$ , while + and - buttons allow you to change the value.

Confirmation by OK is also required for changes to take effect. The third possible setting is the choice of the menu language and, in general, of all the texts displayed by the chronothermostat (Figure 4.2 p. 2).

As previously explained, this setting is requested when the chronothermostat is started for the first time or after a reset; it can then be changed as desired.

#### 4.4.3 Heating control menu

The last item of "Setting menu" concerns the temperature control method used by the chronothermostat to manage the room comfort (Figure 4.27 p. 7).

Figure 4.27 Heating control parameters setting

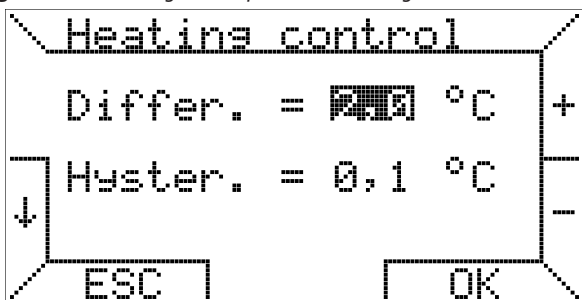

In this page you can set the differential value, which will be used for temperature control only when the assisted remote mode has been set on the OTRG005 thermoregulator (in the other modes the differential value set on the OTRG005 thermoregulator is used). The differential can vary in steps of 0,1 °C between 0,2 °C and 3 °C. The default value is 1 °C.

Given  $T_a$  the measured room temperature value,  $T_i$  the set one, Max the maximum operating power and  $D_i$  the differential value:

- ▶ if  $T_a \leq (T_i - D_i)$  then  $P = \text{Max}$
- ▶ if  $(T_i - D_i) < T_a < T_i$  then  $P = (\text{Max} / D_i) \times (T_i - T_a)$
- ▶ if  $T_a \geq T_i$  then  $P = 0$

Example:

- ▶  $T_i = 20,0 \text{ °C}$
- ▶  $\text{Max} = 100\%$
- ▶  $D_i = 0,5 \text{ °C}$

When  $T_a \leq 19,5 \text{ °C}$  then  $P = 100\%$ . When  $T_a$  is between  $19,6 \text{ °C}$  and  $19,9 \text{ °C}$  then  $P = (100 / 0,5) \times (20 - T_a)$ . When  $T_a \geq 20 \text{ °C}$  then  $P = 0$ , and the gas unit heaters switch off.



For any power requirement value other than 100%, the Next-R gas unit heater will operate at minimum power only.

On the same page you can enter the value of hysteresis (asymmetric) in order to avoid, in some cases, frequent restarts of the

gas unit heaters for short periods of time. The hysteresis can vary in steps of 0,1 °C between 0,1 °C and 50% of the set differential value, with a maximum of 1 °C.

Given  $T_a$  the measured room temperature value,  $T_i$  the set one and Max the maximum operating power:

- ▶ if  $T_a < T_i$  then  $P = \text{Max}$
- ▶ if  $T_a \geq T_i$  then  $P = 0$

Once the set temperature value ( $T_i$ ) has been achieved, the chronothermostat switches the gas unit heaters off: the following restart will occur only if the room temperature drops to  $(T_i - \text{hysteresis})$ , i.e. to the set temperature value reduced by the hysteresis.

The hysteresis default value is 0,5 °C.

Example:

- ▶  $T_i = 20,0 \text{ °C}$
- ▶  $\text{Max} = 100\%$
- ▶  $\text{Hysteresis} = 0,4 \text{ °C}$

When  $T_a \geq 20 \text{ °C}$  then  $P = 0$ , and the gas unit heaters switch off. The units switch on again when  $T_a \leq (T_i - \text{hysteresis}) = 19,6 \text{ °C}$ .

### 4.5 SYSTEM OPERATION - PARAMETERS MENU

This menu allows remote management of the operating parameters of gas unit heaters.

You can scroll through the various items with  $\uparrow$  and  $\downarrow$  buttons. The selection menu occupies two pages (Figure 4.28 p. 7 and Figure 4.29 p. 7), and switching between them is automatic, selecting the item below (or above, to return to the first page).

Figure 4.28 Parameters menu - first page



Figure 4.29 Parameters menu - second page

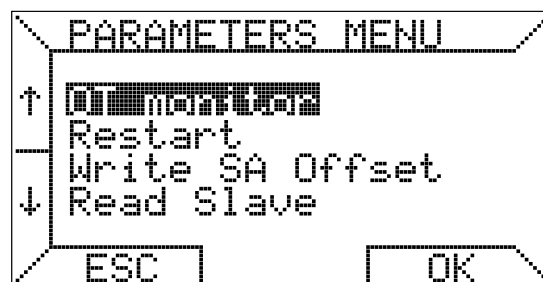

The first item "Settings" allows you to view and set the remote parameters called TSP (Transparent parameters) for the system. TSP are password protected.

You must enter the value 10 and press OK to activate the first page of parameter reading.

Figure 4.30 p. 8 shows the first page of the settings menu; to go to the next pages you need to use the  $\uparrow$  and  $\downarrow$  buttons.

**Figure 4.30** Settings menu - first page

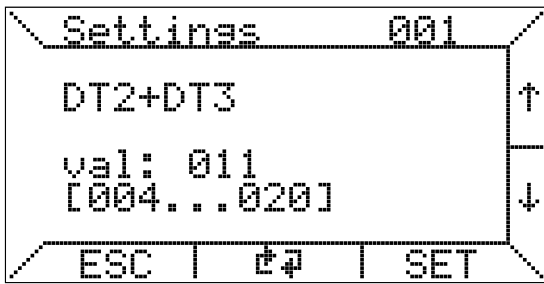

To change a parameter, move to the desired settings page (with ↑ and ↓ buttons) and press SET, then enter with + and - buttons, in the page that will appear, the chosen value between the minimum and maximum limits, indicated in square brackets.



For information on the meaning of the parameters and the consequences of changing them, refer to the technical documentation of the OTRG005 thermoregulators of the gas unit heaters connected to the chronothermostat.

However, you can operate directly on the TSPs by selecting the third item "TSP" (Figure 4.31 p. 8) that opens the TSP reading page.

**Figure 4.31** "TSP Read" page

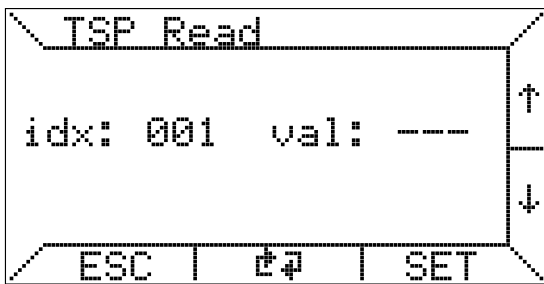

The functions made available by the chronothermostat are the reading and eventually writing of the TSPs.

To change a TSP you need to move to the desired "idx" index, using the ↑ and ↓ buttons, and press the SET button; operating in this way the page shown in Figure 4.32 p. 8 appears.

In "TSP Write" you can enter the desired value using the + or - buttons. If the board does not provide for the writing of such TSP (read-only), any changes made to it will not take effect.

The number of TSPs is dependent on the thermoregulators (gas unit heaters). The chronothermostat supports up to 10 of them.

**Figure 4.32** "TSP Write" page

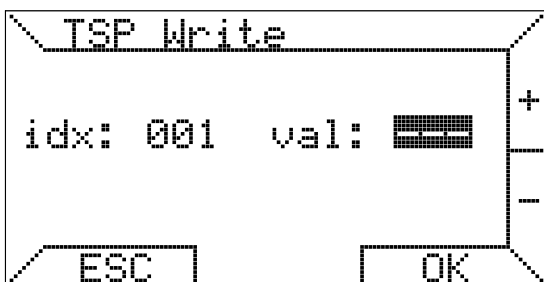

The second item of the "Parameters menu" allows you to use the unlock command (Figure 4.33 p. 8).

**Figure 4.33** Reset request

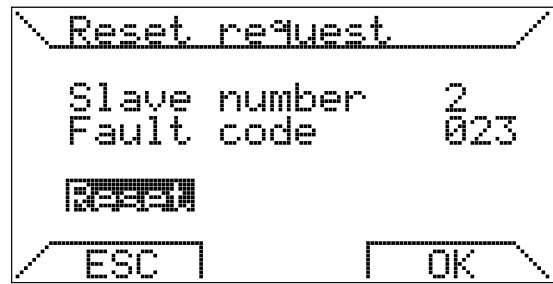

If a gas unit heater is locked, you can send a remote unlock request by selecting the command "Reset" and pressing OK. Since this is a safety function, the actual unlocking of the gas unit heater can only take place upon consent of the safety logic of the connected thermoregulator.

If the remote unlocking is enabled, in case of locking it is possible to press the central transparent button (detail B Figure 4.1 p. 2).

The items "OT monitor" and "Restart" are reserved for service operations on the chronothermostat.

**Figure 4.34** Reconnection function

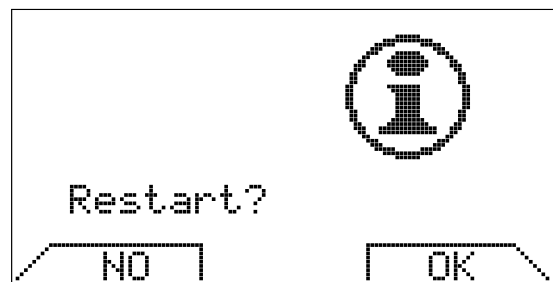

The function "Restart", on the other hand, is used to reconfigure the chronothermostat after hardware/software operations on the thermoregulator while the chronothermostat is running (without disconnecting the power supply), in the event that such operations could modify the system configuration.

Activating the reconnection is equivalent to physically disconnecting the communications connector from the chronothermostat and then reinserting it.

With the "Write SA Offset" parameter you can set an offset value to be given to the room temperature value for each thermoregulator.

This may be useful if the gas unit heaters are installed in colder or warmer places than the point where the chronothermostat is installed.

**Figure 4.35** Room temperature offset setting

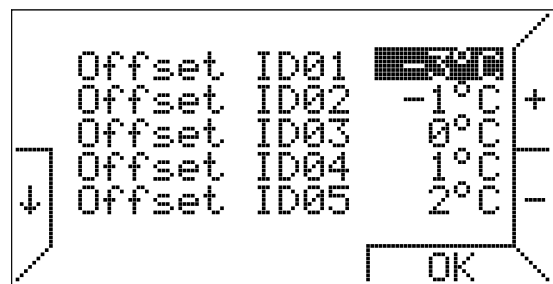

A number of settable offsets are shown, equal to the number of connected thermoregulators, up to a maximum of 10. For example, looking at Figure 4.35 p. 8 and the set offsets, if



the set room temperature is 22 °C then thermoregulator 1 works with setpoint 22 °C - 3 °C = 19 °C, thermoregulator 2 works with setpoint 22 °C - 1 °C = 21 °C and so on.  
 In the last item "Read Slave" of the "Parameters menu" you can view the operating status of the thermoregulators and the reading of the respective temperature probe.

Figure 4.36 "Read Slave" page

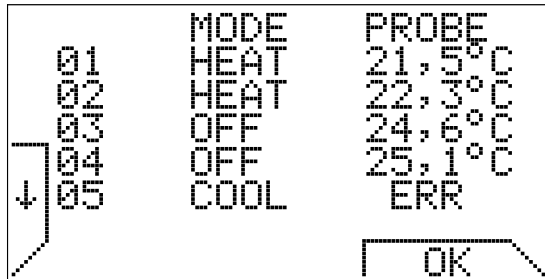

Here too, a number of lines are shown, corresponding to the number of connected thermoregulators, up to a maximum of 10. You can also display the "Read Slave" screen by pressing from the home page, in any operation mode, even when the key lock is active, keys 1 and 2 simultaneously as shown in Figure 4.37 p. 9.

Figure 4.37 Shortcut to "Read Slave" page

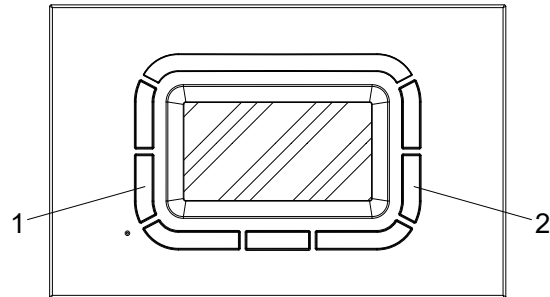

Press simultaneously keys 1 and 2 to show "Read Slave" page

## 5 SPECIFIC FUNCTIONS

### 5.1 INTERNAL POWER RESERVE AND BATTERY USAGE

The chronothermostat is equipped with an internal power reserve that can buffer the absence of power for a few hours, so that the user can avoid resetting the current time, room temperatures and weekly program.

However, the time it takes for the power reserve to run down varies depending on the humidity and the room temperature, as well as the ageing of the electronic components.

For the power reserve to be fully operational, the chronothermostat must have been correctly and continuously powered for at least a couple of days.

It should be noted that when the power supply (and serial communication) is restored, the parameters stored by the thermoregulator connected to the chronothermostat are loaded.

If frequent and/or prolonged disconnections of the power supply are expected, it is possible to avoid loss of the chronothermostat data by installing 2 alkaline batteries of the AAA LR03 1.5 V type in the appropriate housing on the support base, respecting polarity.

In this way, the additional power reserve, in the case of new batteries, can store data for more than a year without power supply. It is advisable not to leave the batteries inside the chronothermostat for a long time during normal operation (power supply available), in order to avoid liquid leaks that could damage the chronothermostat itself.

### 5.2 STORING DATA IN THE MEMORY OF CHRONOTHERMOSTAT

If the internal power reserve, described in Paragraph 5.1 p. 9, is discharged, the chronothermostat still stores some data in memory so as not to have to enter them again the next time you turn it on.

In particular, the weekly program, the temperatures (T1, T2, T3), if modified for the automatic operation mode, the last activated operation mode, the hysteresis value and the offset values of the room temperature setpoint (SA) are saved and sent to the slaves present in the "Write SA Offset" item of the "Parameters menu".

### 5.3 PROGRAM RESET

You can reload the default weekly temperature program (T1, T2, T3) through the appropriate "Programming reset" item of the "Programming" menu of the "Setting menu".

There is no quick reset for the hysteresis value nor for the room temperature probes (SA) offset values.



By pressing the reset button, the weekly program, the temperatures (T1, T2, T3), the last activated operating mode, the hysteresis value and the offset values of the room temperature setpoint (SA) that are sent to the slaves in the "Write SA Offset" menu of the "Parameters menu" are not reset.

### 5.4 WARNINGS ON THE BACKLIGHT

The display backlighting is derived from the power reserve described in Paragraph 5.1 p. 9.

It is possible, therefore, that in the case of a chronothermostat that has just been connected, the brightness is minimal or absent due to insufficient internal power reserve: this must not alarm because just a few hours of connection are enough for the backlight to begin to be efficient.

It is possible, if desired, to remedy this temporary lack of backlighting by installing alkaline batteries, paying attention to polarity and following the instruction in the Paragraph 5.1 p. 9.

## 6 INSTALLATION INSTRUCTIONS

**i** Observe the applicable national and European electrical safety regulations.

**i** Connect and disconnect the chronothermostat only in the absence of voltage.

**i** Before commissioning, check the cables carefully; incorrect wiring may damage the devices and compromise the safety of the system.

**i** Avoid exposing the chronothermostat to dripping water.

### 6.1 CONNECTION TO THE GAS UNIT HEATER BOARD

**Figure 6.1** OCDS008 digital chronothermostat connection

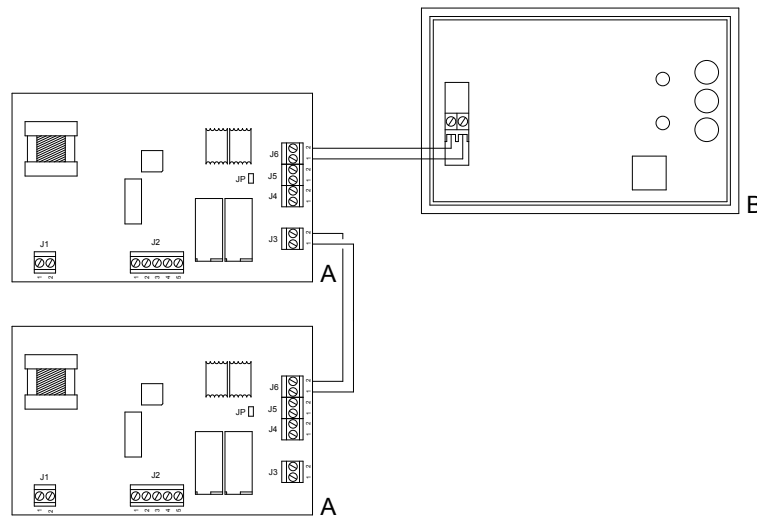

- A OTRG005 thermoregulator
- B OCDS008 digital chronothermostat

### 6.2 WALL INSTALLATION

To fix the base to a wall, first of all, disconnect the cover containing the electronic user interface board by gently pressing on the trapezoidal button provided, which bears the words "push", located at the bottom of the chronothermostat, and turning the front panel upwards, until it is fully removed, as shown in Figure 6.2 p. 10.

**Figure 6.2** Removing the cover

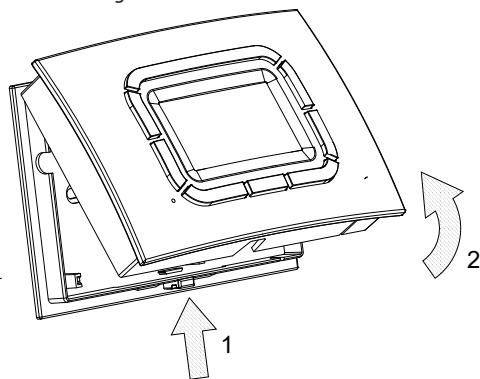

- 1 "Push" button
- 2 Turn the cover upwards

The holes provided at the bottom of the base can be used for fixing (Figure 3.2 p. 7).

Once the base has been fixed, it is possible to connect the chronothermostat using the special removable terminal block and regardless of the polarity (the two wires can be switched).

It is recommended to use a twisted pair cable (e.g. H03RR-F or H03VV-F) with a cross-section between 0.5 mm<sup>2</sup> and 2,5 mm<sup>2</sup> and not to exceed 50 m in length, remembering that the resistance of each conductor, in any case, must not exceed 5 Ω. In environments with particularly strong electromagnetic interference, it is recommended to use a shielded twisted pair cable. Once the wiring has been completed, the cover must be reinserted on the base using upper hooks and turn downwards unit the lever hook clicks.

## 6.3 TREE MENU

### Chronothermostat switch on

1. Language setting request
2. Time setting

#### First level menu

- ▶ Operating mode: manual of programmed
- ▶ Summer mode: yes/no
- ▶ Standby: yes/no
- ▶ Overtime mode: yes/no
- ▶ **Setting menu:** yes/no
  - Programming
    - Temperatures
    - Day program
    - Day copy
    - Program reset
  - Time setting
  - Language setting
  - Heating control
- ▶ Maximum power
- ▶ **Parameters menu:** yes/no
  - Settings
    - TSP read
    - TSP write
  - Reset
  - TSP
  - OT monitor
  - Restart
  - Write SA Offset
  - Read slave
- ▶ Heating system control panel
- ▶ Auto mode: yes/no

## INDEX OF CONTENTS

<b>1 Description</b> .....	<i>p. 1</i>	<b>5 Specific functions</b> .....	<i>p. 9</i>
<b>2 Features</b> .....	<i>p. 1</i>	5.1 Internal power reserve and battery usage.....	<i>p. 9</i>
<b>3 Technical characteristics</b> .....	<i>p. 1</i>	5.2 Storing data in the memory of chronothermostat .....	<i>p. 9</i>
<b>4 Operating instructions</b> .....	<i>p. 1</i>	5.3 Program reset.....	<i>p. 9</i>
4.1 Language setting .....	<i>p. 2</i>	5.4 Warnings on the backlight .....	<i>p. 9</i>
4.2 Time setting .....	<i>p. 2</i>	<b>6 Installation instructions</b> .....	<i>p. 10</i>
4.3 First level menu.....	<i>p. 2</i>	6.1 Connection to the gas unit heater board.....	<i>p. 10</i>
4.4 Chronothermostat operation - Setting menu .....	<i>p. 5</i>	6.2 Wall installation .....	<i>p. 10</i>
4.5 System operation - Parameters menu .....	<i>p. 7</i>	6.3 Tree menu.....	<i>p. 11</i>