

## AMBIENT AIR CURTAIN AB 175H, AB 225H



<b>INDEX</b>	<b>Section</b>
General Information -----	1
Dimensions -----	2
Technical Specifications -----	3
Installation Details -----	4
Wiring Details -----	5
Servicing -----	6
Parts Replacement -----	7
Spare Parts -----	8
Fault Finding -----	9
User Instructions -----	10

### **WARNINGS**

- 1 This appliance must only be installed by a competent person in accordance with the requirements of the Codes of Practice or the rules in force.
- 2 All external wiring **MUST** comply with the current IEE wiring regulations.
- 3 Warning this appliance must be earthed.

# 1. General Information.

Welcome to the Airbloc ABH ambient air curtain models. Local regulations may vary in the country of use and it is the installers responsibility to ensure that such regulations are satisfied.

All installation, assembly, commissioning and service procedures must be carried out by suitably qualified competent persons to the statutory regulations in the country of use.

When assembling, installing, commissioning and servicing is undertaken on the air curtains is required to ensure that working at height regulations are adhered to at the mounting heights specified.

All dimensions shown are in mm unless otherwise stated.

The manufacturer reserves the right to alter specifications without prior notice.

**!** *PLEASE READ this document prior to installation to familiarise yourself with the components and tools you require at the various stages.*

The primary reason for installing an air curtain is

to prevent the influx of cold outside air through a door opening into a heated area. Typical applications include large despatch bay doors in factories and warehouses, and internal doors between areas of different temperatures. Wider door openings can be accommodated by bolting two or more units together.

Air curtains control the internal climate by emitting an air stream with enough velocity to meet the floor so creating an air barrier in the door area. To prevent the ingress of outside draughts, the discharge louvre is angled outwards, so that the air leaving the building meets the wind trying to enter, thus deflecting it. (See diagrams below).

Airbloc air curtains provide uniform air distribution across the full width of the door, keeping heated or conditioned air inside the building and stopping the ingress of cold air, draughts and dust.

This manual provides detailed information on the installation of Airbloc air curtains. It is essential that these products are installed in accordance with these manufacturers instructions.



Without air curtain

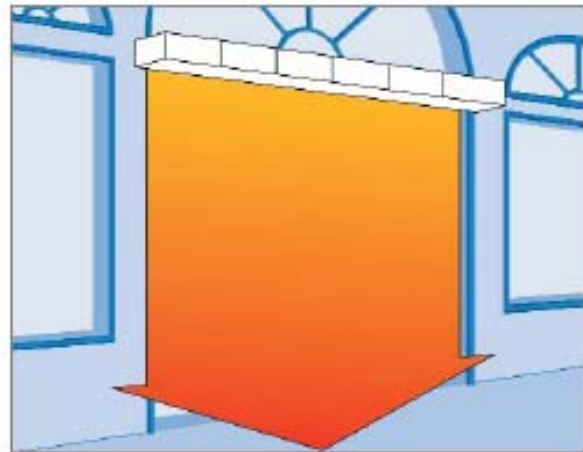

With air curtain

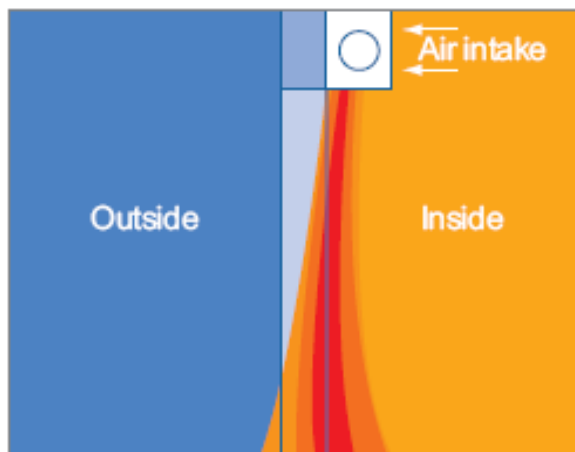

Pattern of airflow

## 2. Dimensions.

Diagram 1: Dimensions

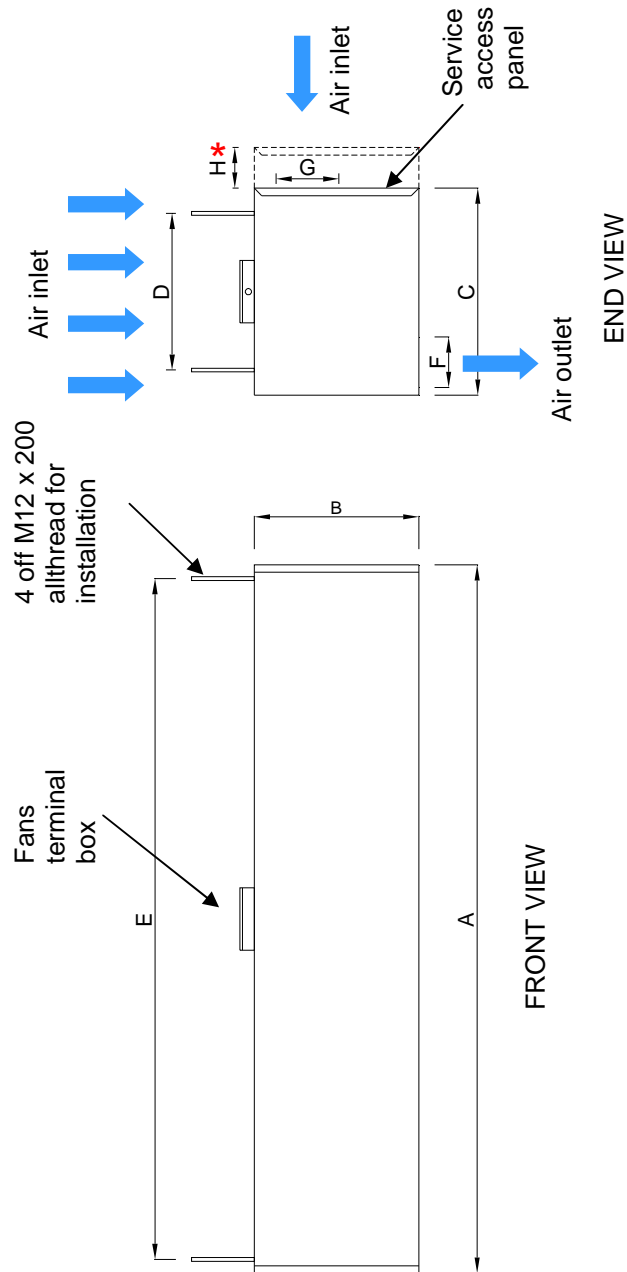

Model	A mm	B mm	C mm	D mm	E mm	F mm	G mm	H mm	Weight (kg)
AB 175H	1763	525	660	500	1674	162	200	130	180
AB 225H	2260	525	660	500	2172	162	200	130	205

\* Typical projection showing LPHW/steam housing (dimension H). LPHW/steam coils available to order. See contact details on rear cover of this document.

### 3. Technical Specifications.

		Air curtain model	
		AB 175H	AB 225H
<b>Air distribution fans</b>			
Type	Centrifugal		
Speeds	1		
No. of fans	3	4	
Maximum air volume	13020m <sup>3</sup> /hr	17360m <sup>3</sup> /hr	
Voltage	415V 3PH 50Hz 3 wire		
Power rating (per fan)	750 W		
Current (per fan)	3.1A (FLC)		
Start current (per fan)	7.75A		
<b>Power</b>			
Fans total electrical power consumption	2.25kW	3.0kW	

#### Constitution

Model	AB175H	AB225H
AB350H=	X 2	
AB400H=	X 1	X 1
AB450H=		X 2
AB525H=	X 3	
AB575H=	X 2	X 1
AB625H=	X 1	X 2
AB675H=		X 3

## 4. Installation Details.

### Health and Safety

Due account should be taken of any obligations arising from the Health and Safety at Work Act Etc. 1974 or relevant codes of practice. In addition the installation must be carried out in accordance with the current IEE wiring regulations and any other relevant British Standards and Codes of Practice, by a qualified installer. Isolate all electrical supplies to the heater and control panel before proceeding. For your own safety we recommend the use of personal protective equipment when handling this air curtain.

Airbloc air curtains are supplied with 12mm mounting rods pre-fitted, and can be mounted either as single units, or in multiples, which can be fixed together to suit various door widths. The maximum mounting height is 9 metres, and the minimum 4.5 metres (See diagram 2 below).

#### 4.1

Each single air curtain should be suspended by its factory fitted mounting rods secured to the building structure. (See diagram 3, page 6).

#### 4.2

Multiple air curtains should be fixed together using suitable support channels (not supplied) fixed along the full length of the adjacent air curtains to spread the load.

The assembly can now be fixed back to the

building structure by bolting directly using suitable support brackets, or suspending from above using steelwork. (See diagram 4 page 6). If required, the support channel may be extended slightly past the ends of the air curtains to aid fixing.

**!** *Note: Where multiple air curtains are fitted above up and over doors or where central support is inappropriate, the support channel should be replaced with channels of a greater cross section to prevent the assembly from bending.*

It may be necessary to adjust the position of the air outlet louvres to provide the correct airflow across the door opening. This can be done by first loosening the four locking pins located two at each end of the louvres (arrowed, Fig. A), then loosening the intermediate locking Allen pins (arrowed, Fig. B). The louvres can now be moved to the desired position and the locking pins re-tightened.

**!** *Note: The AB 225H model has two pairs of intermediate locking Allen pins, whereas the AB 175H model only has one pair.*

### 4.3 Mounting.

Diagram 2.

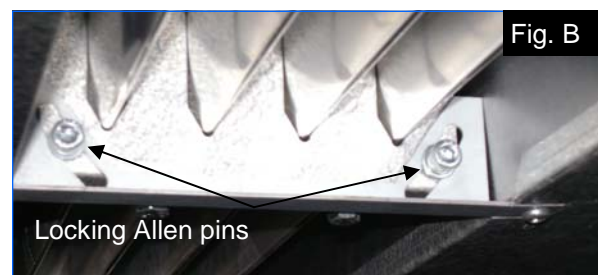
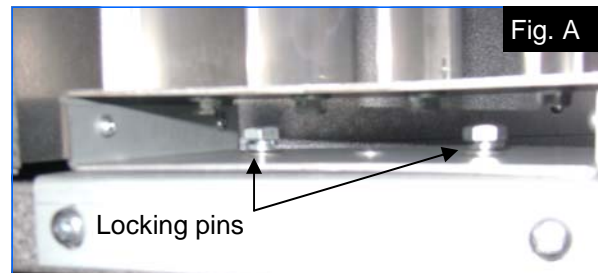
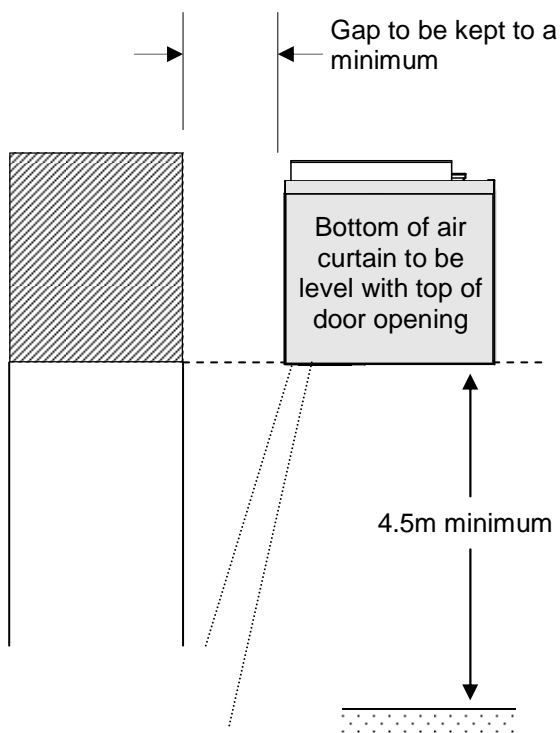

## 4. Installation Details cont.

**Diagram 3:** Mounting method (single air curtain)

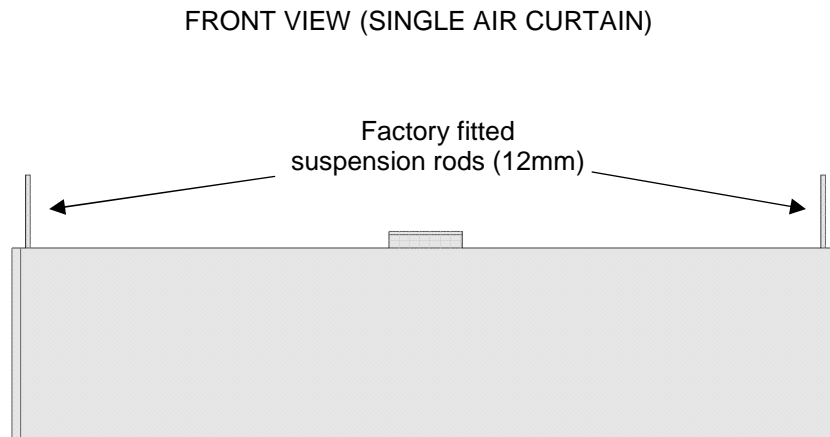

**Diagram 4:** Support channel (multiple air curtains)

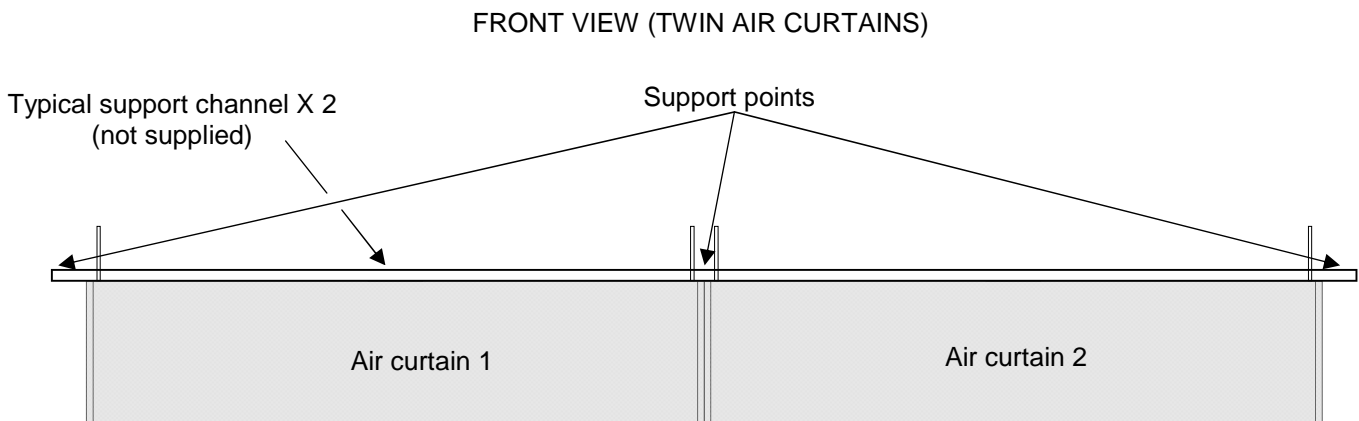

Factory fitted support rods may be used to fix through the support channel. The channel should then be secured using 12mm locking nuts and washers. The support rods can then be cut to length as required.

## 5. Wiring Details.

### 5.1 Control panel.

The electrical control panel incorporates the facility to interlock with the door opening mechanism and automatically switch the air curtain on and off as the door is opened and closed. A pair of volt free auxiliary contacts are required on the door open/close contactor which closes as the door opens. If this is not available then a suitably positioned limit switch and striker plate will need to be fitted to the door. The panel incorporates an auto/off/manual selector switch, which, when in 'auto' mode

operates the air curtain as the door opens and closes. The 'manual' position overrides the door interlock, and the 'off' position turns the air curtain off.

The panel also contains a removable jumper on the main terminal rail to allow the air curtain to be interlocked with a fire alarm system if required.

The panel is fitted with a low voltage (24V AC) control circuit for the fire alarm/door controls.

**Diagram 5:** Generic control panel wiring (a customer specific wiring diagram is supplied in each air curtain control panel).

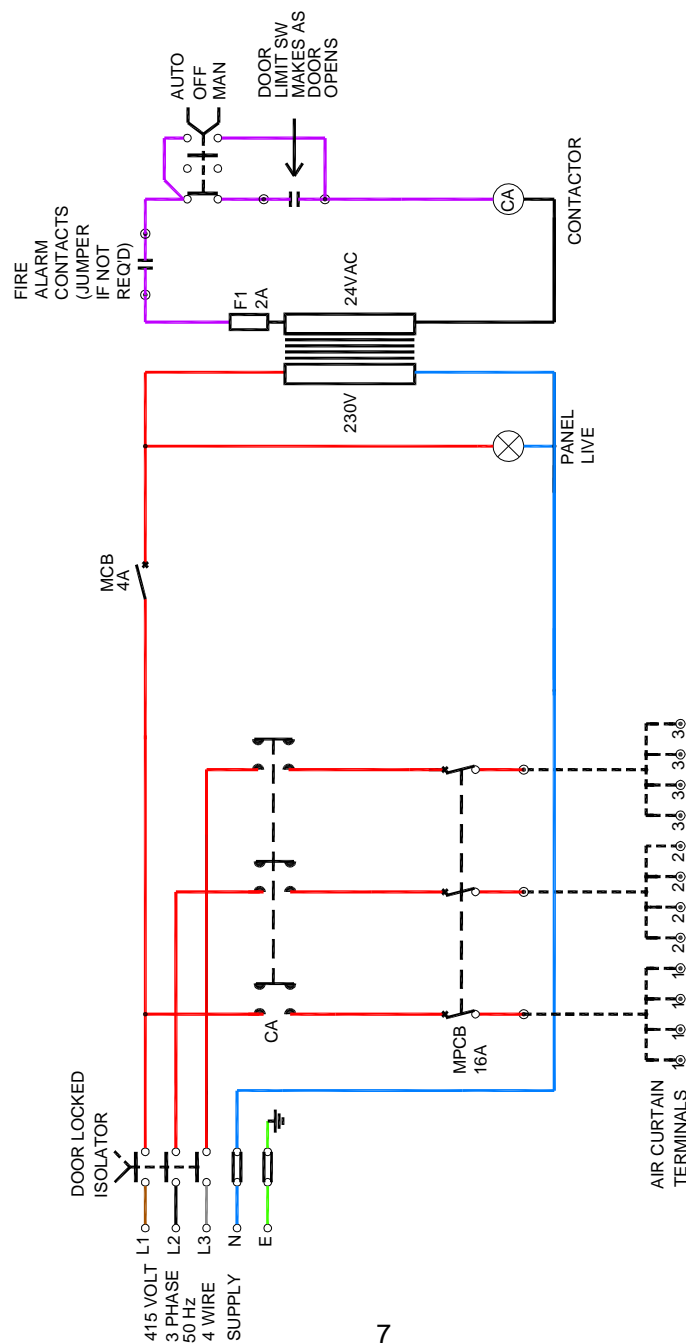

## 5. Wiring Details cont.

Diagram 6. Motor speed options

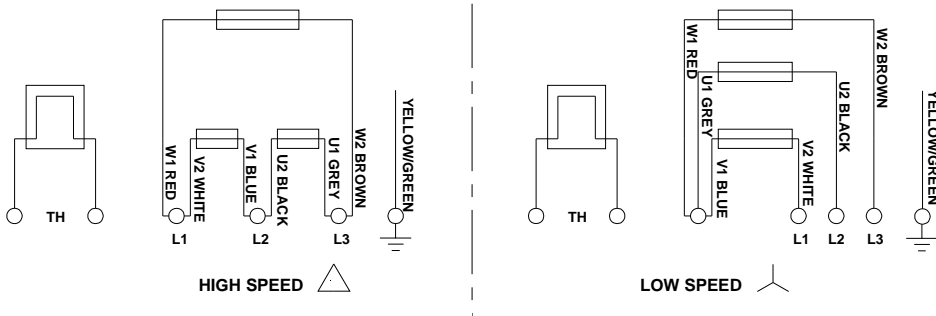

The air curtains leave the factory with the fans wired in delta (high speed). If required the motors can be wired in star as shown in diagram 6 to give a speed reduction but with less airflow. The wiring may be changed within the terminal box on single motors or all the motors in any ABH air curtain.

## 6. Servicing.

These appliances should be serviced annually by a competent person to ensure safe and efficient operation. In exceptionally dusty or polluted conditions more frequent servicing may be required. The manufacturer offers a maintenance service. Details available on request.

**! Isolate electricity supplies before commencing any work.**

### 6.1 Tools required.

The following tools and equipment are recommended to complete the tasks laid out in this section.

**! Suitable alternative tools may be used.**



Cross point screwdriver



Small flat head screwdriver



13mm spanner



10mm spanner



Allen key set



Soft brush

### 6.2 Air outlet louvres.

The air outlet louvres should be cleaned with a soft brush. Check that the louvres are set to the required angle. (See Figs. A/B on page 5 for setting procedure).

top of the air curtain (Fig.1), and repeat previous procedure for the fan terminations.

Switch control panel on and check air curtain for correct operation in each selector switch position (auto/off/man)

### 6.3 Air distribution fans.

The air distribution fans can be accessed by removing the fan access cover as described in section 7.1.

Clean off any dust or deposits with a soft brush paying particular attention to the impeller. Check that the impeller spins freely, and that there is no play in the fan bearings.

The fan(s) can be removed, if necessary, as described in section 7.1. to 7.1.4

### 6.4 Electrical.

**! Isolate electricity supplies before commencing any work.**

Check condition and tightness of all terminations in control panel.

Remove the fans terminal box cover located on



Fig.1



## 7. Parts Replacement.

! *All servicing/maintenance work on this air curtain should be carried out by suitably qualified person. Before commencing any work please ensure that the electricity supplies are turned off.*

### 7.0 Tools required.



8mm spanner

### 7.1 Air distribution fans.

The air distribution fans can be accessed by removing the 10 M6 (AB175H), or 12 M6 (AB225H) bolts around the edge of the air inlet grille and removing to reveal fans. (Figs.2/3)

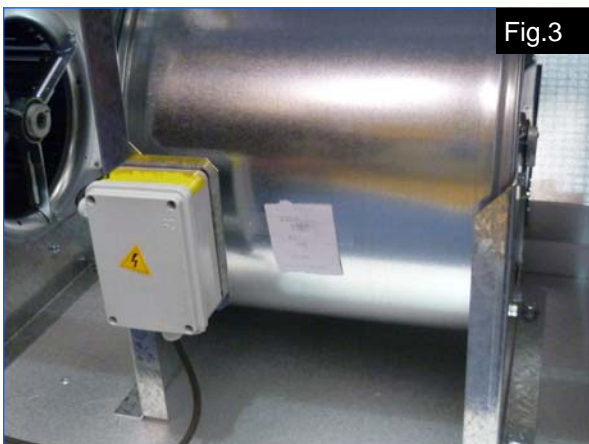
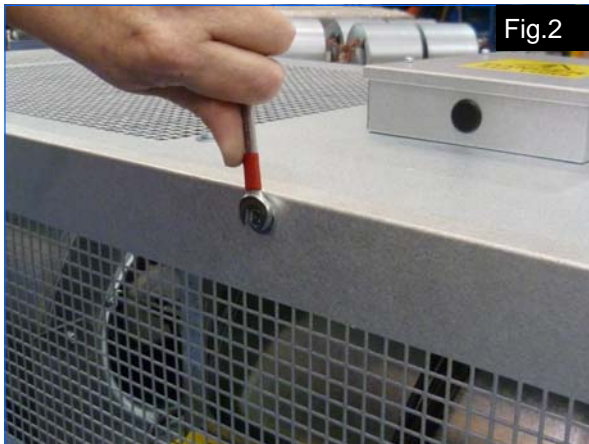

### 7.1.1 Fan wiring

Remove the four screws securing the terminal box lid. (fig.4).



### 7.1.2

Remove the three incoming cables plus the earth from the connector strip. (Fig.5).

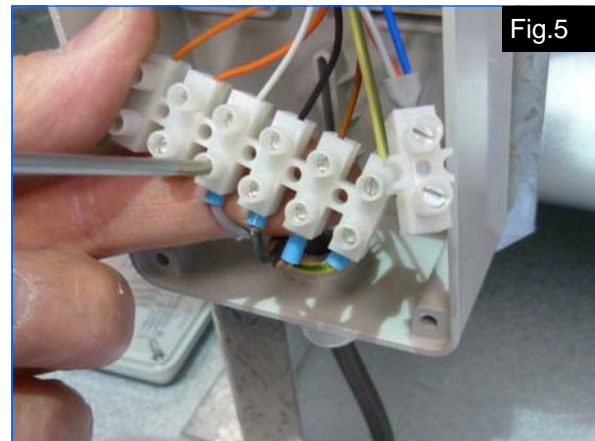

### 7.1.3

Remove the hex head self taper securing the motor feed cable clip the move the cable out of the way. (Fig.6).



## 7. Parts Replacement cont.

### 7.1.4 Fan removal

Remove the four M10 bolts securing the base of the fan ( Fig.7 )

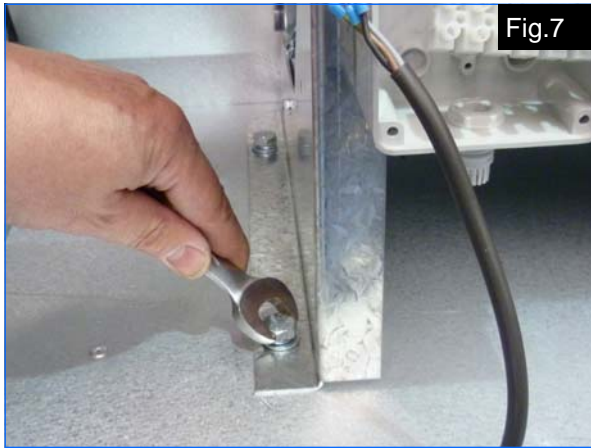

Fig.7

Slide the fan unit forward then lift clear of the air curtain. (Fig.9)

**! CAUTION: Fan units are heavy, two person lift may be required.**

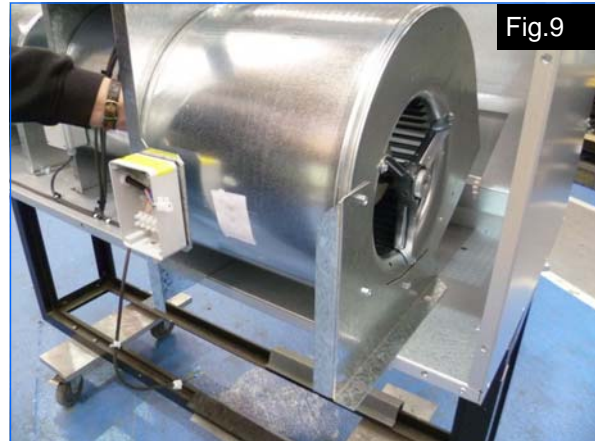

Fig.9

Remove the two M6 bolts securing the motor bracket to the top of the air curtain case ( Fig.7 )



Fig.8

Replacement of parts is reversal of procedures previously described.

## 8. Spare Parts.

The air distribution fans are available as a spare part as detailed below.

Item	Description	Part No.
	Air distribution fan unit	AB-FAN-HC

**! Note: Any spare parts or components used that are not approved by AmbiRad could invalidate the approval of the appliance and also the warranty.**

## 9. Fault Finding.

### Air distribution fans

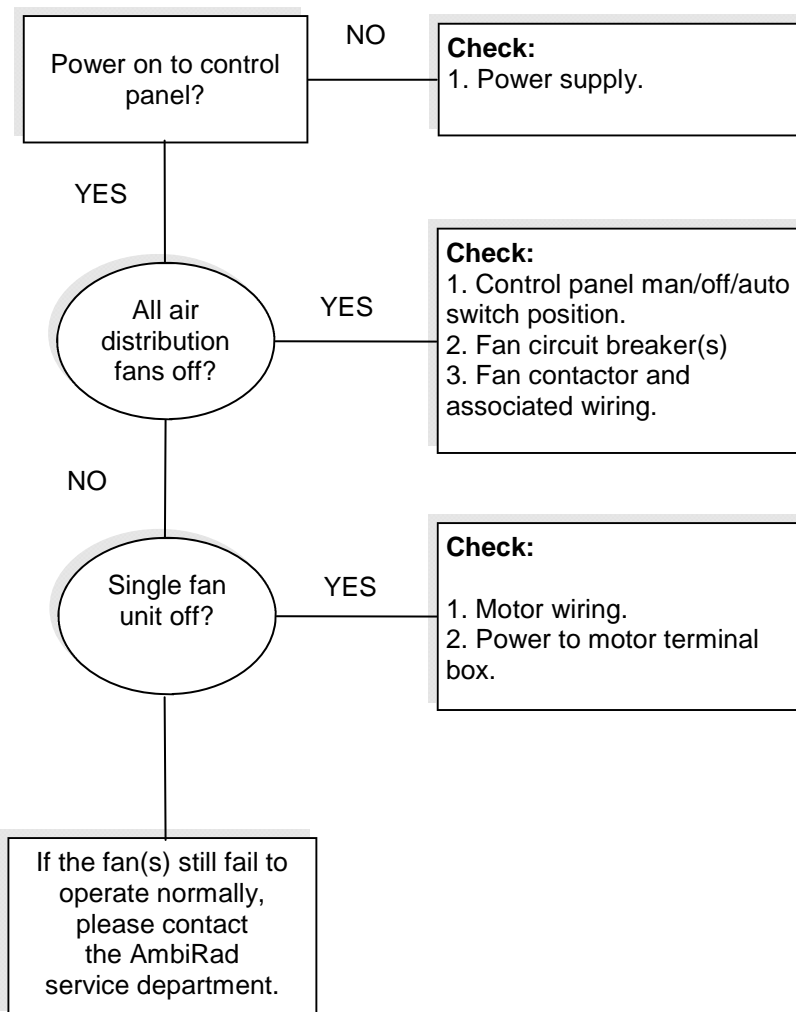

## 10. User Instructions.

### 10.1 Important information

This appliance must only be installed by a competent person in accordance with the requirements of the codes of practice and the rules in force in the country of use.

**10.1.1** The appliance **must** be earthed.

**10.1.2** Never rest anything, especially ladders, against the air curtain.

### 10.2 To start the ABH air curtain (manual)

**10.2.1** Rotate the control panel auto/off/manual selector switch to the 'manual' position.

**10.2.2** Switch on electrical supply to the control panel. The panel live lamp will illuminate and the air distribution fans will start.

### 10.3 To start the ABH air curtain (auto)

**10.3.1** Rotate the control panel auto/off/manual selector switch to the 'auto' position.

**10.3.2** Switch on electrical supply to the control panel. The panel live lamp will illuminate and the air distribution fans will only start if the door is in the raised position.

### 10.4 To switch off the ABH air curtain

**10.4.1** Rotate the auto/off/manual control panel selector switch to the 'off' position. The air distribution fans will stop. Switch off the electrical supply to the control panel. The panel live lamp will extinguish.

### 10.6 Servicing

To ensure continued efficient and safe operation it is recommended that the air curtain is serviced regularly by a competent person, once a year in normal working conditions, but in exceptionally dusty or polluted conditions more frequent servicing may be required.

*The manufacturer, (AmbiRad address given below), offers a maintenance service, details of which are available on request.*

*For sales related queries please contact the Nordair Niche address given below.*



Nordair Niche (Northern Office)  
6-14 Bean Leach Road,  
Hazel Grove, Stockport,  
Cheshire. SK7 4LD  
United Kingdom



Telephone 0161 482 7900  
Facsimile 0161 482 7901  
Email marketing@nordairniche.co.uk  
Website www.nordairniche.co.uk

AmbiRad Limited Fens Pool Avenue  
Brierley Hill West Midlands DY5 1QA  
United Kingdom.

Telephone 01384 489700  
Facsimile 01384 489707  
Email marketing@airbloc.co.uk  
Website www.airbloc.co.uk  
Technical Support www.s-i-d.co.uk

An AmbiRad Group brand

**AIRBLOC**  
ENERGY SAVING AIR CURTAINS