

ELECTRIC AIR CURTAIN AB 175E, AB 225E

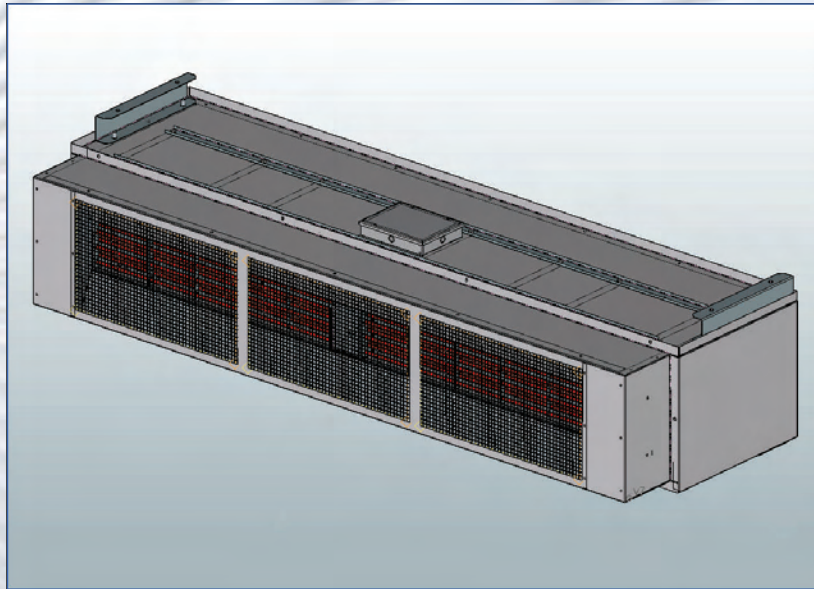

INDEX	Section
General Information -----	1
Dimensions -----	2
Technical Specifications -----	3
Installation Details -----	4
Wiring Details -----	5
Servicing -----	6
Parts Replacement -----	7
Spare Parts -----	8
Fault Finding -----	9
User Instructions -----	10

WARNINGS

- 1 This appliance must only be installed by a competent person in accordance with the requirements of the Codes of Practice or the rules in force.
- 2 All external wiring **MUST** comply with the current IEE wiring regulations.
- 3 Warning this appliance must be earthed.

1. General Information.

Welcome to the new Airbloc AB electric air curtain models. Local regulations may vary in the country of use and it is the installers responsibility to ensure that such regulations are satisfied.

All installation, assembly, commissioning and service procedures must be carried out by suitably qualified competent persons to the statutory regulations in the country of use.

When assembling, installing, commissioning and servicing is undertaken on the air curtains is required to ensure that working at height regulations are adhered to at the mounting heights specified.

All dimensions shown are in mm unless otherwise stated.

The manufacturer reserves the right to alter specifications without prior notice.

! *PLEASE READ this document prior to installation to familiarise yourself with the components and tools you require at the various stages.*

The primary reason for installing an air curtain is

to prevent the influx of cold outside air through a door opening into a heated area. Typical applications include large despatch bay doors in factories and warehouses, and internal doors between areas of different temperatures. Wider door openings can be accommodated by bolting two or more units together.

Air curtains control the internal climate by emitting an air stream with enough velocity to meet the floor so creating an air barrier in the door area. To prevent the ingress of outside draughts, the discharge louvre is angled outwards, so that the air leaving the building meets the wind trying to enter, thus deflecting it. (See diagrams below).

Airbloc air curtains provide uniform air distribution across the full width of the door, keeping heated or conditioned air inside the building and stopping the ingress of cold air, draughts, and dust.

This manual provides detailed information on the installation of Airbloc AB electric air curtains. It is essential that these products are installed in accordance with these manufacturers instructions.



Without air curtain

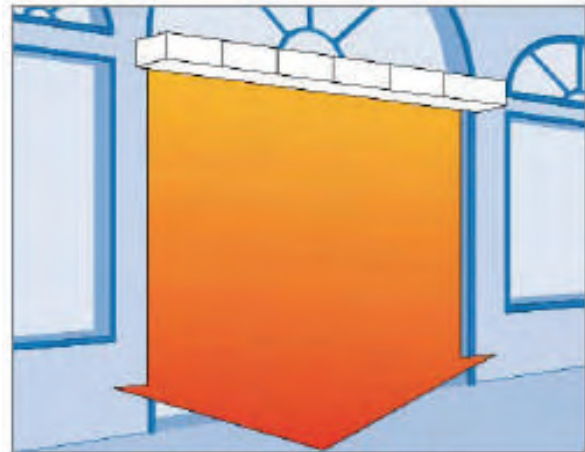

With air curtain

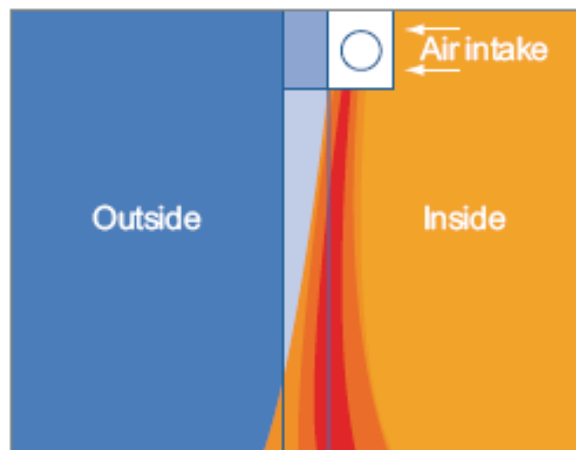

Pattern of airflow

2. Dimensions.

Diagram 1: Dimensions

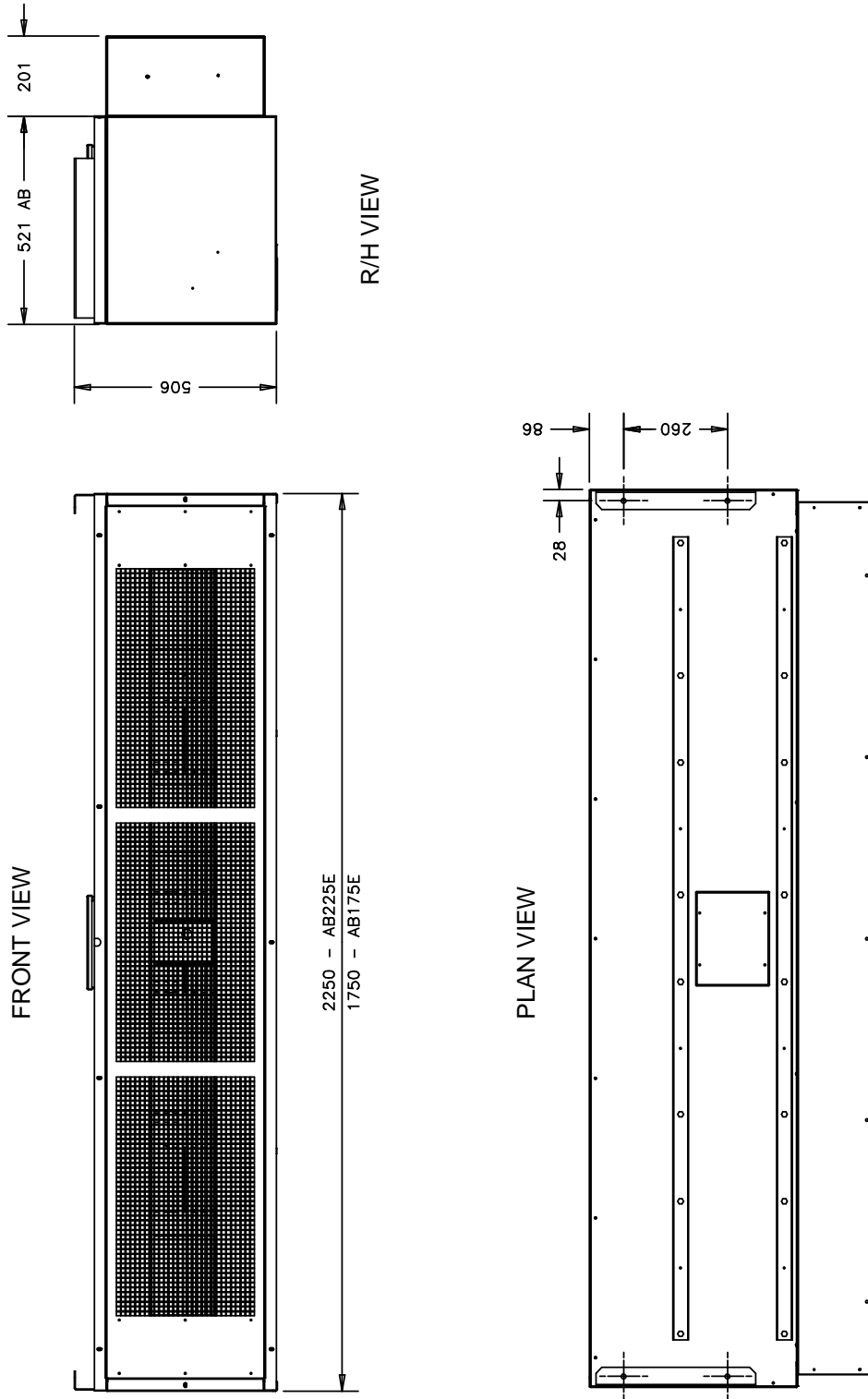

3. Technical Specifications.

		Air curtain model	
		AB 175E	AB 225E
Air distribution fans			
Type	Centrifugal (with integral thermal trip)		
Speeds	3		
No. of fans	3	4	
Maximum air volume	7068m ³ /hr	9425m ³ /hr	
Voltage	230V 1PH 50Hz		
Power rating (per fan)	550 W		
Current (per fan)	4.5A (FLC)		
Start current (per fan)	11.25A		
Power			
Elements	18kW	24kW	
Total power consumption	19.65kW	26.2kW	
Temperature rise (Δ T)			
High speed	9.7°C	7.28°C	
Low speed	13.86°C	10.39°C	

4. Installation Details.

Health and Safety

Due account should be taken of any obligations arising from the Health and Safety at Work Act 1974 or relevant codes of practice. In addition the installation must be carried out in accordance with the current IEE wiring regulations and any other relevant British Standards and Codes of Practice by a qualified installer. Isolate all electrical supplies to the heater & control panel before proceeding.

For your own safety we recommend the use of personal protective equipment when handling

Airbloc electric air curtains are supplied with mounting brackets pre-fitted, and can be mounted either as single units, or in multiples, which can be bolted together to suit various door widths.

The minimum mounting height is 3 metres (See diagram 2 below).

4.1

Each single air curtain should be supported by cantilever brackets (not supplied) then fixed back to the building structure by bolting directly using suitable support brackets, or by suspending from above using suitable steelwork. (See diagram 3, page 6).

4.2

Multiple air curtains should be bolted together

4.3 Mounting.

Diagram 2.

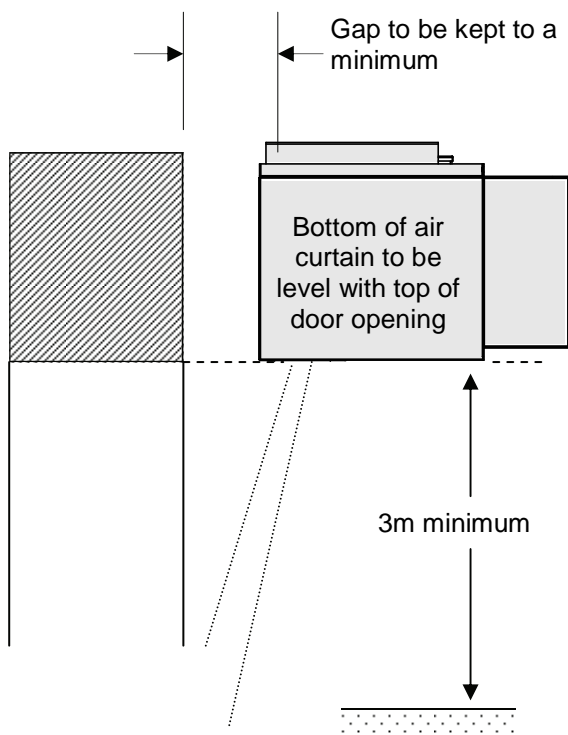

using 3 off M10 set pins, nuts and washers fitted through the holes provided in the mounting brackets, then suitable support channels (not supplied) must be fixed on top of the factory fitted brackets along the full length of the assembled air curtains to spread the load.

The assembly can now be fixed back to the building structure by bolting directly using suitable support brackets, or suspending from above using steelwork. (See diagram 4 page 6). If required, the support channel may be extended slightly past the ends of the air curtains to aid fixing.

! Note: Where multiple air curtains are fitted above up and over doors or where central support is inappropriate, the support channel should be replaced with channels of a greater cross section to prevent the assembly from bending.

It may be necessary to adjust the position of the air outlet louvres to provide the correct airflow across the door opening. This can be done by first loosening the four locking pins located two at each end of the louvres (arrowed, Fig. A), then loosening the intermediate locking Allen pins (arrowed, Fig. B). The louvres can now be moved to the desired position and the locking pins re-tightened.

! Note: The AB 225 model has two pairs of intermediate locking Allen pins, whereas the AB 175 model only has one pair.

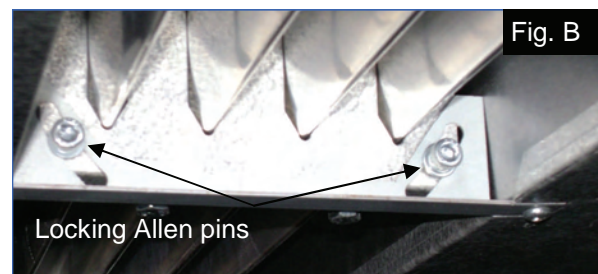
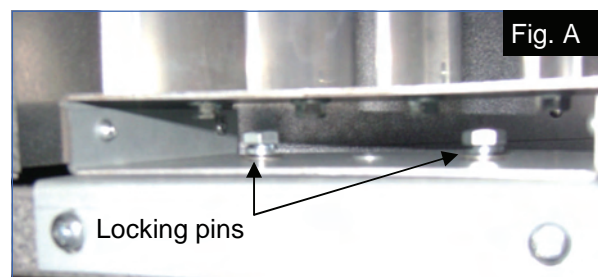

4. Installation Details cont.

Diagram 3: Mounting method (single air curtain)

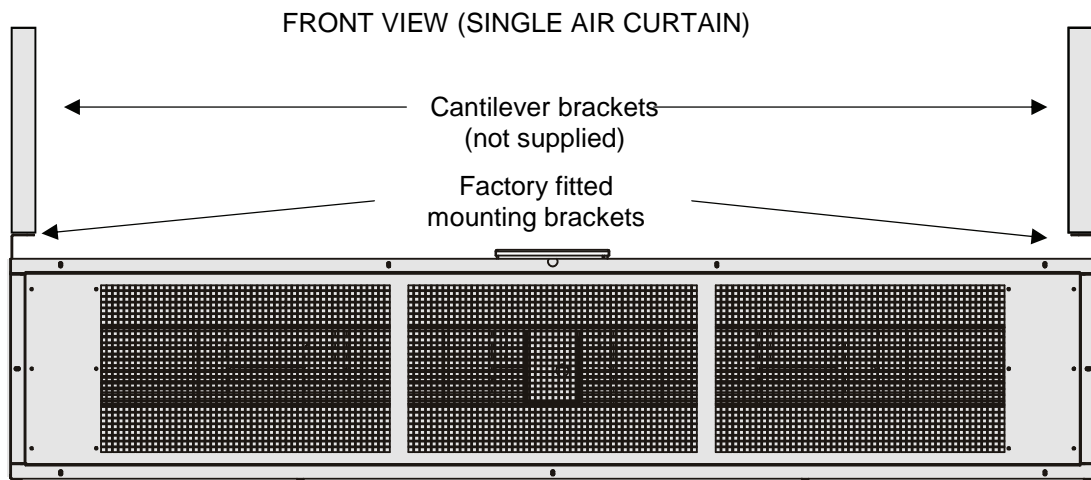
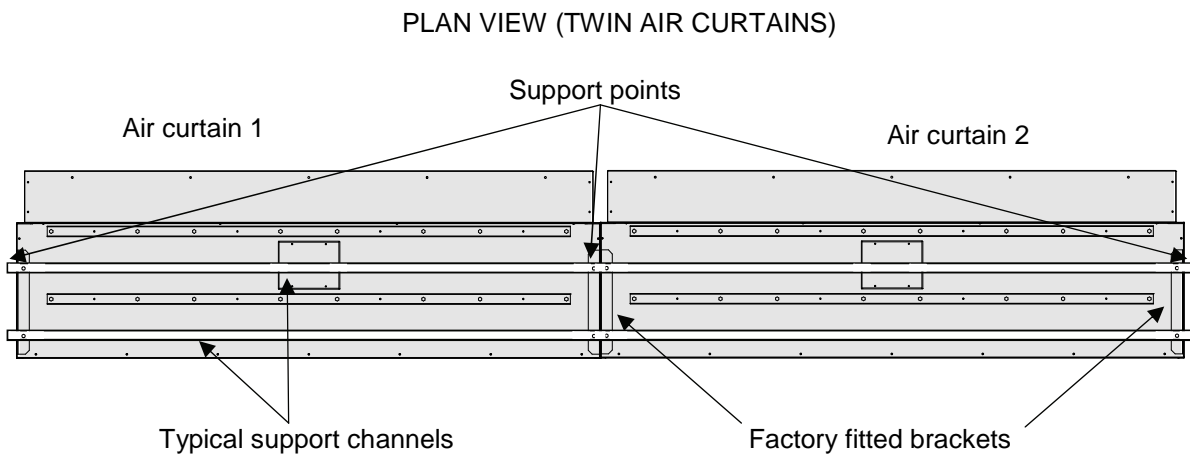

Diagram 4: Support channel (multiple air curtains)



5. Wiring Details.

5.2 Control panel.

The panel incorporates an on/off selector switch, a high/low fan speed selector switch, and a heat on/off selector switch.

Panel operation is described in section 10 of this manual (user instructions).



A customer specific control panel wiring diagram will be supplied within each air curtain control panel.

Diagram 5: Generic control panel wiring (sheet1)

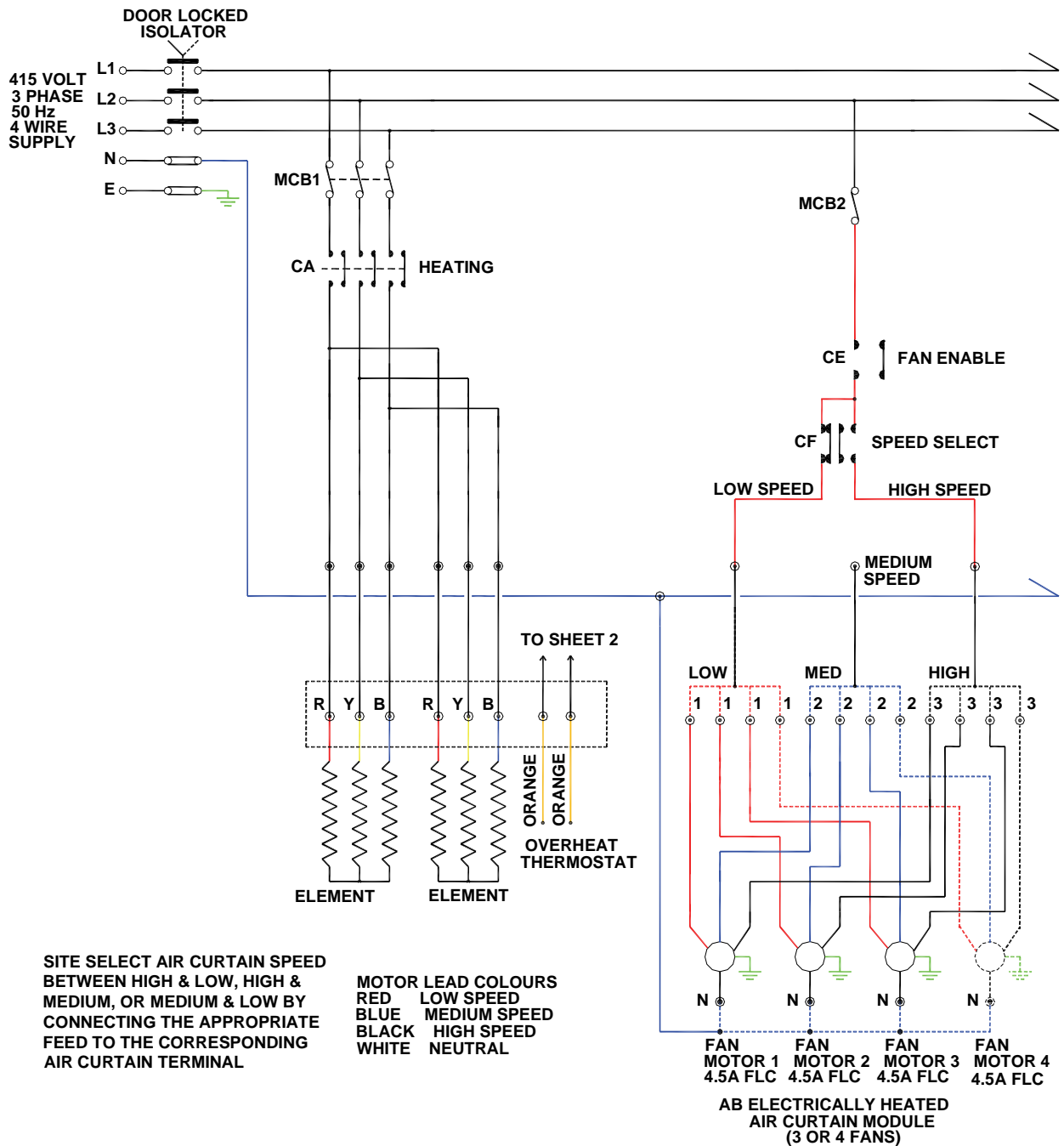

5. Wiring Details cont.

Diagram 6: Generic control panel wiring (sheet2)



A customer specific control panel wiring diagram will be supplied within each air curtain control panel.

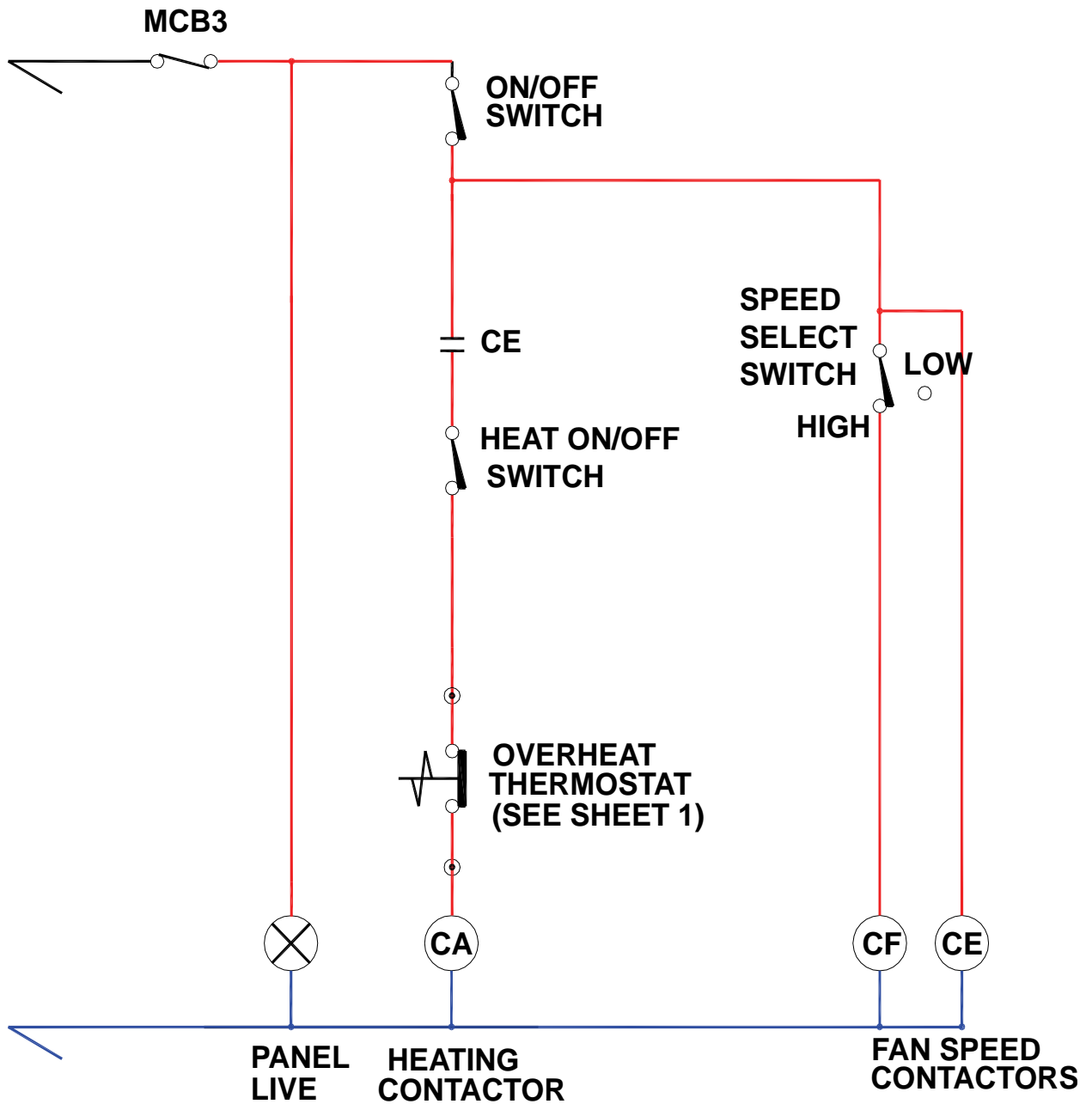

6. Servicing.

! These appliances should be serviced annually by a competent person to ensure safe and efficient operation. In exceptionally dusty or polluted conditions more frequent servicing may be required. The manufacturer offers a maintenance service. Details available on request. **Isolate electricity supplies before commencing any work.**

6.1 Tools required.

The following tools and equipment are recommended to complete the tasks laid out in this manual.

! Suitable alternative tools may be used.



6.2 Air outlet louvres.

The air outlet louvres should be cleaned with a soft brush. Check that the louvres are set to the required angle. (See Figs. A/B on page 5 for setting procedure).

6.3 Air distribution fans.

The air distribution fans can be accessed by opening the fan access lid as described in section 7.1 Fig.2.

Clean off any dust or deposits with a soft brush paying particular attention to the impeller. Check that the impeller spins freely, and that there is no play in the fan bearings.

The fan(s) can be removed, if necessary, as described in section 7.1.

6.4 Elements

Remove element housing as described in section 7 (parts replacement). Clean off any dust or deposits with a soft brush.

Visually inspect element coils for signs of discolouration, burning, sagging etc.

6.5 Electrical.

! **Isolate electricity supplies before commencing any work.**

Check condition and tightness of all terminations in control panel.

Remove the fan/elements terminal box cover located on top of the air curtain (Fig.1), and repeat above procedure for the fan/elements terminations.

Check that the plug/socket connection to each fan (inside the unit) is tight and that the cable is in good condition. Switch control panel on and check air curtain operation in each selector switch position (heat on/off, low//high speed).

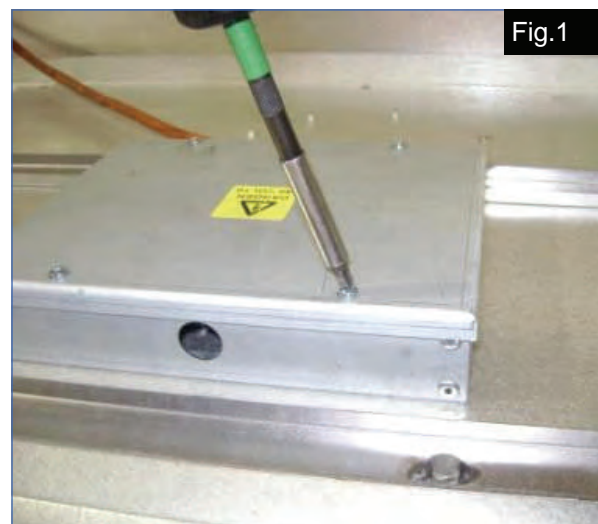

All servicing/maintenance work on this air curtain should be carried out by suitably qualified

7. Parts Replacement.

! person. Before commencing any work please ensure that the electricity supplies are turned off.

7.0 Tools required.

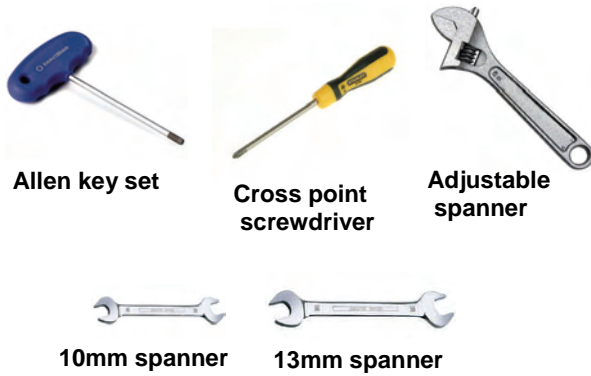

7.1 Air distribution fans.

The air distribution fans can be accessed by removing the the three screws along the bottom edge of the air inlet grille (Fig.2), and the retaining screws securing the hinged lid on the underside of the air curtain next to the louvres (Fig.3)

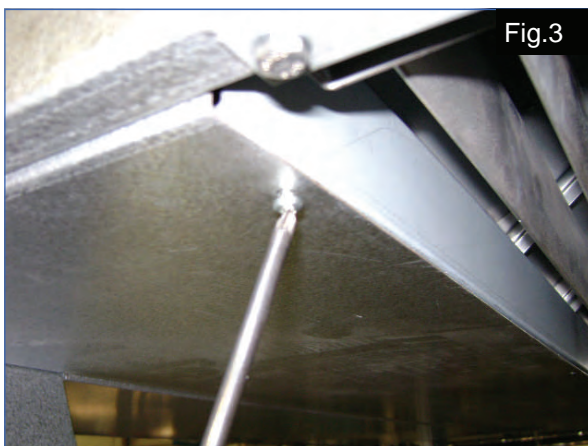
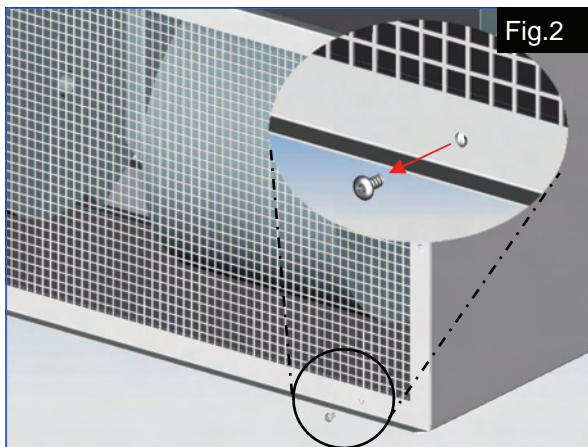

The lid can now be hinged down to access the fans as shown in Fig.4.

7.1.1 Fan closure plate

Before individual fans can be removed it will be necessary to remove the fan closure plate. Remove the retaining screws around the perimeter of the plate. (See Figs.5/6) The plate can now be removed.

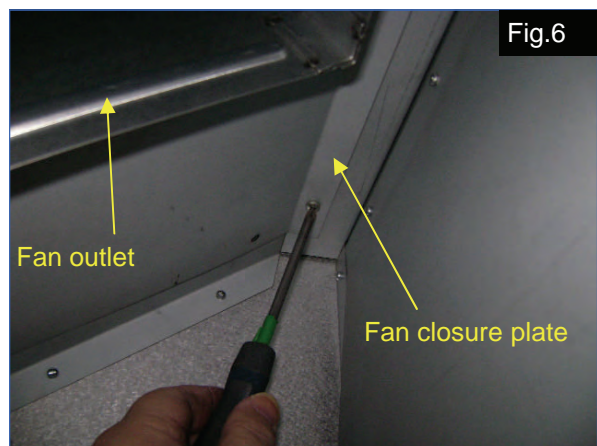
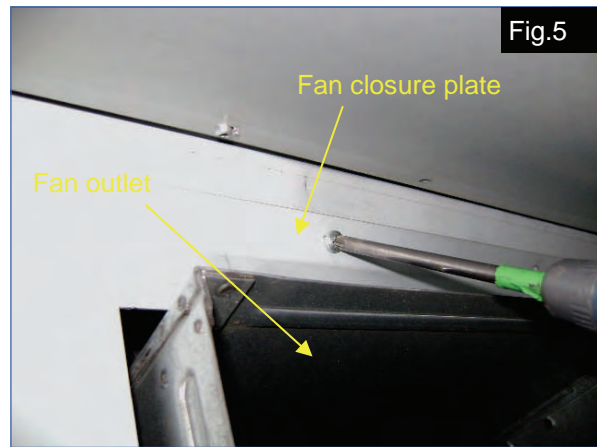

7. Parts Replacement cont.

7.1.2 Fan removal

Identify the feed cable for the fan requiring removal and disconnect it from its cable mounted plug/socket. (See Fig.7)

The four bolts securing the fan can now be removed as shown in Fig.8, and the fan removed from the air curtain downwards.

CAUTION: these fan units are heavy.

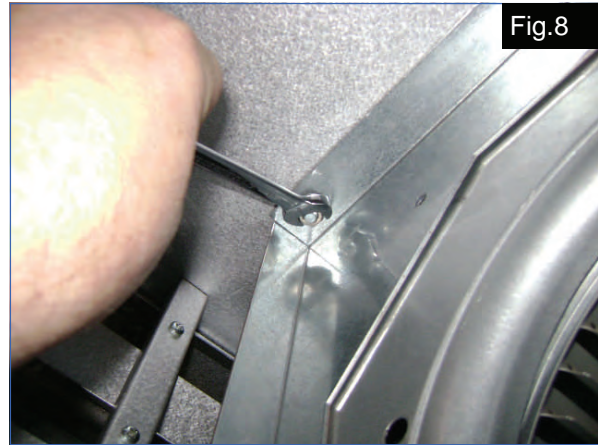
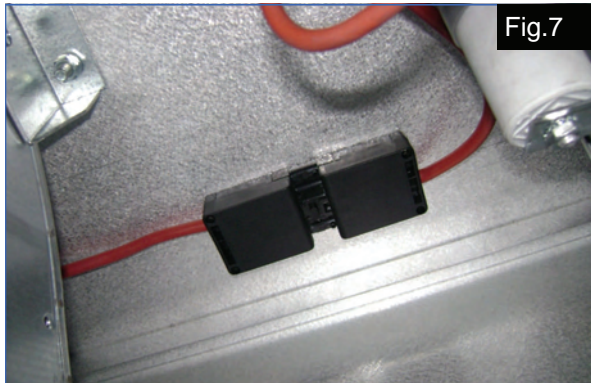
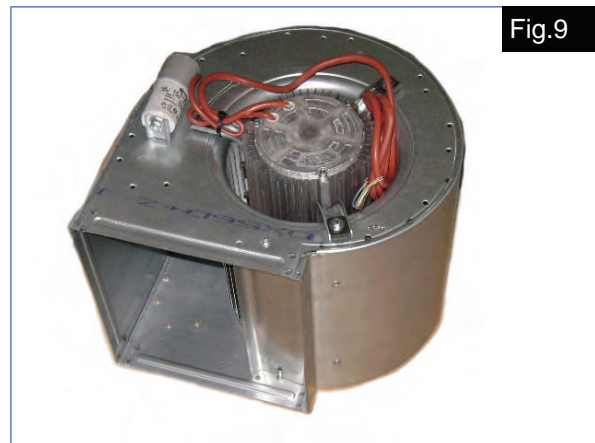
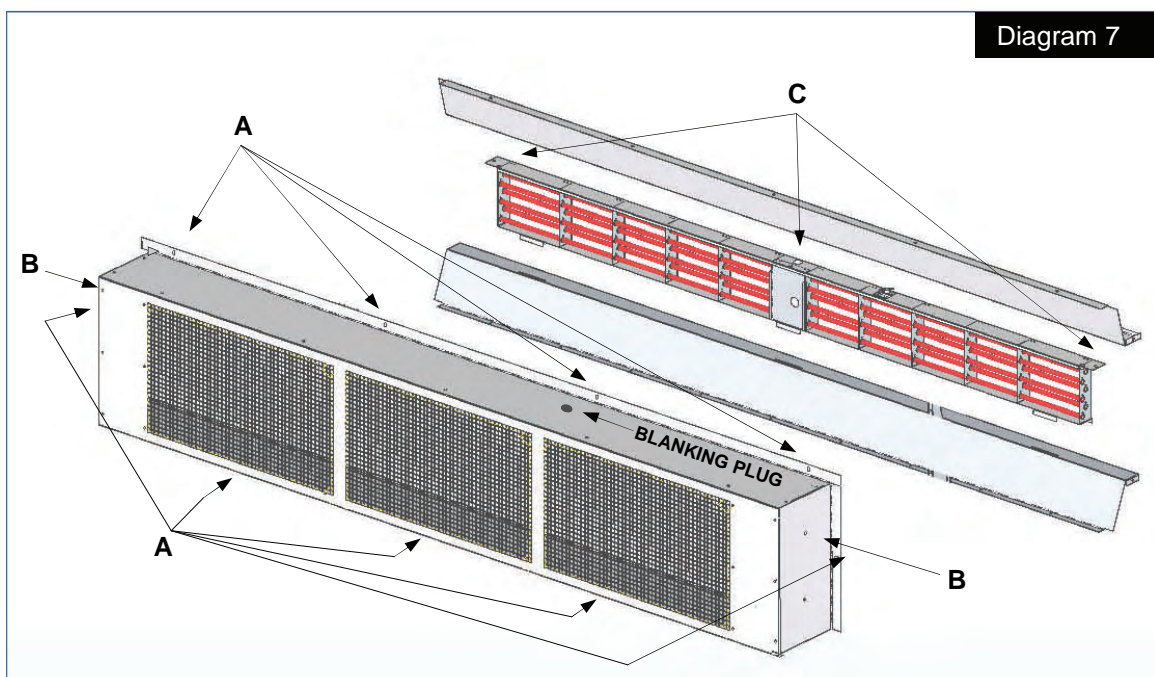

Fig.9 shows single air distribution fan in isolation for clarity.



7.2 Heating element removal (see Diagram 7)

7.2.1 To gain access to the elements first remove the 9 screws (A) retaining the element housing.



7. Parts Replacement cont.

7.2.2 Remove the 2 screws (**B**) retaining the top element plate ends.

7.2.3 Remove the 3 screws (**C**) retaining the top rail of the element assembly.

7.2.4 The element assembly can now be tilted forward slightly and lifted from the 3 retaining tab slots (**D**). See diagram 8.

7.2.5 The wiring to the element assembly can now be accessed at the rear of panel (**E**), and disconnected after first noting the cable positions.

7.2.6



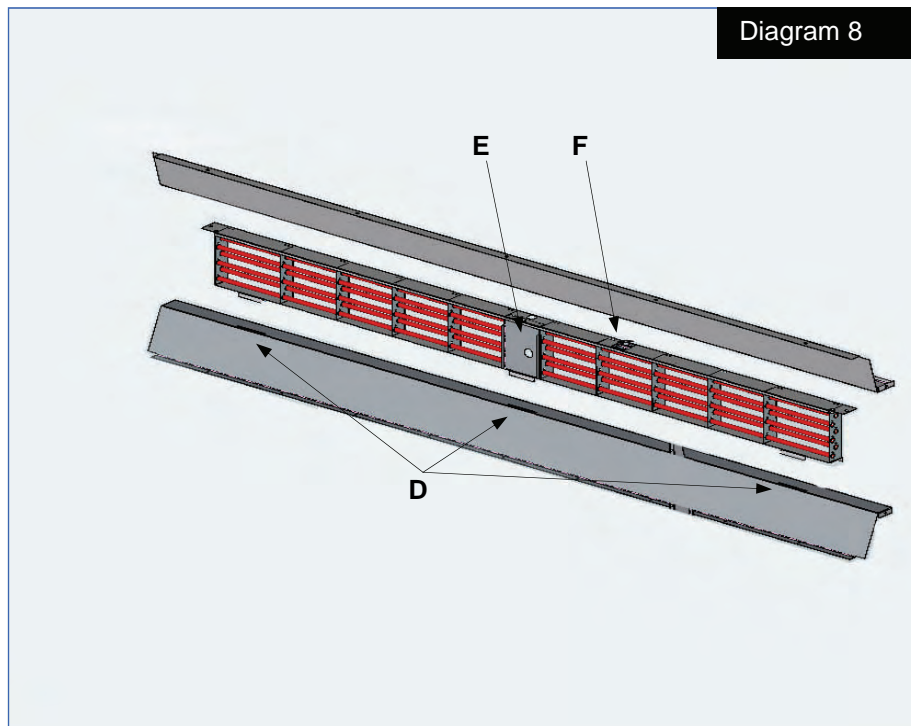

Finally disconnect the two female spade connectors from the overheat thermostat (**F**). The element assembly can now be withdrawn from the air curtain.

7.2.7

Refitting a new element assembly is the reverse of the above procedure.

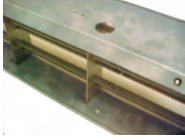
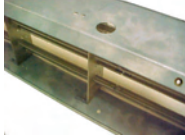

8. Spare Parts.

Item	Description	Part No.	Item	Description	Part No.
	3 speed air distribution fan unit	AB-FAN		Air distribution fan 5 pin plug/ socket	Plug: 3127 Socket: 3126
	AB 225E 24kW elements (full set)	100528		AB 175E 18kW elements (full set)	100527
	Thermal cutout (1 per module)	900001	 <i>Note: Any spare parts or components used that are not approved by AmbiRad could invalidate the warranty of the appliance.</i>		

9. Fault Finding.

Air distribution fans

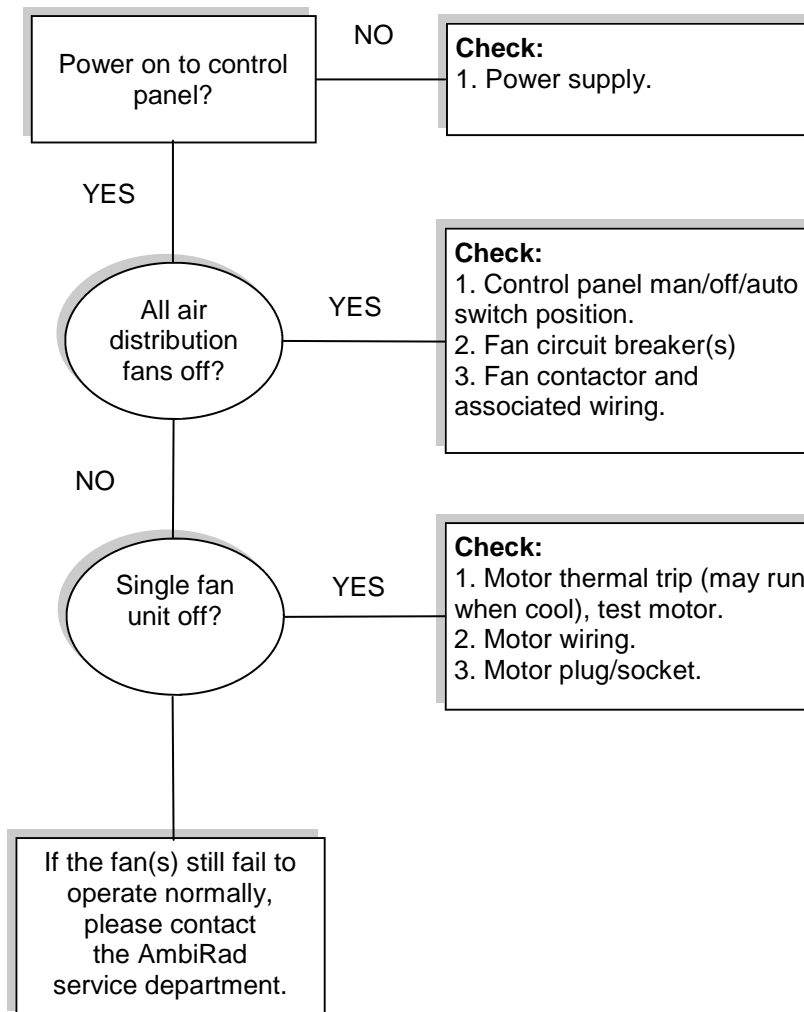

9. Fault Finding cont.

Elements

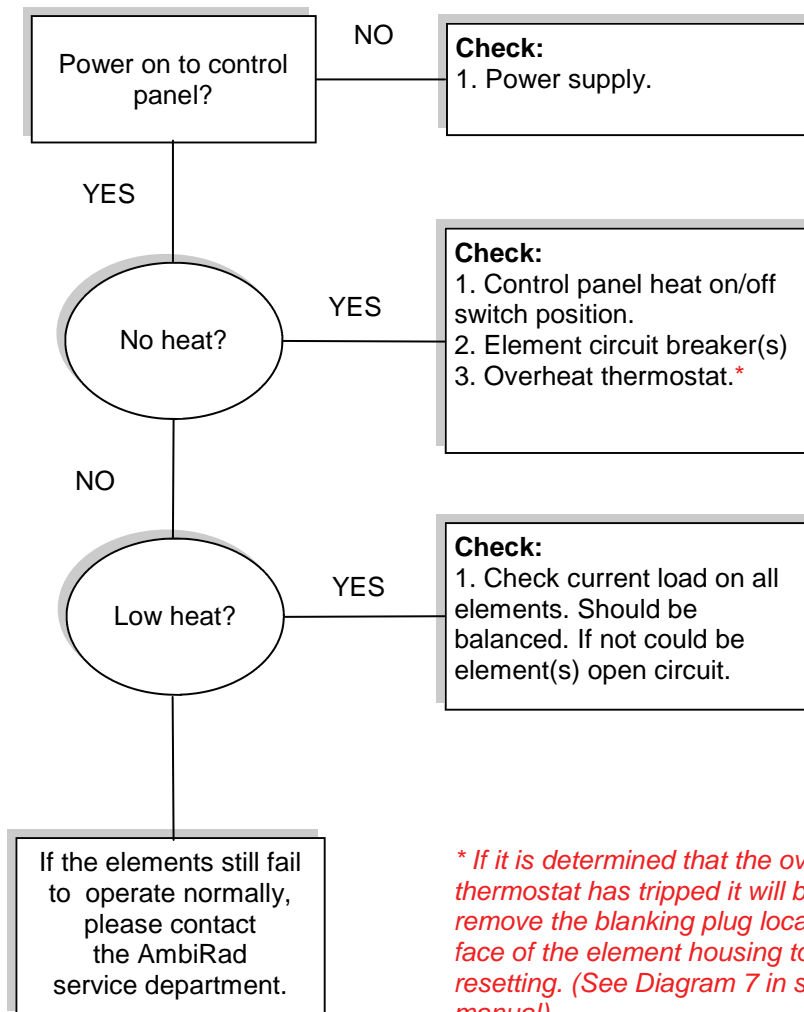

** If it is determined that the overheat thermostat has tripped it will be necessary to remove the blanking plug located on the top face of the element housing to enable resetting. (See Diagram 7 in section 7 of this manual).*

This MUST be done with the electrical supply to the air curtain turned OFF.

10. User Instructions.

10.1 Important information

This appliance must only be installed by a competent person in accordance with the requirements of the codes of practice and the rules in force in the country of use.

10.1.1 The appliance **must** be earthed.

10.1.2 Never rest anything, especially ladders, against the air curtain.

10.2 To start the AB air curtain

10.2.1 Rotate the control panel on/off selector switch to the 'on' position.

10.2.2 Rotate the high/low selector switch to the desired position.

10.2.3 Rotate the heat on/off selector switch to the desired position.

10.2.4 Switch on electrical supply to the control panel. The panel live lamp will illuminate, the air distribution fans will start and, if selected, heating elements will be on.

10.3 To start the AB air curtain (BMS control, if specified)

10.3.1 Rotate the control panel on/off/ selector switch to the 'on' position.

10.3.2 Rotate the high/low selector switch to the desired position.

10.3.3 Rotate the heat on/off selector switch to the desired position.

10.3.2 Switch on electrical supply to the control panel. The panel live lamp will illuminate and the unit will now only operate when the BMS relay or remote switch is closed.

10.5 To switch off the AB air curtain

10.5.1 Rotate the on/off control panel selector switch to the 'off' position.

10.6 Servicing

To ensure continued efficient and safe operation it is recommended that the air curtain is serviced regularly by a competent person, once a year in normal working conditions, but in exceptionally dusty or polluted conditions more frequent servicing may be required.

The manufacturer, (AmbiRad address given below), offers a maintenance service, details of which are available on request.

For sales related queries please contact the Nordair Niche address given below.



Nordair Niche (Northern Office)
6-14 Bean Leach Road,
Hazel Grove, Stockport,
Cheshire. SK7 4LD
United Kingdom



Telephone 0161 482 7900
Facsimile 0161 482 7901
Email marketing@nordairniche.co.uk
Website www.nordairniche.co.uk

AmbiRad Limited Fens Pool Avenue
Brierley Hill West Midlands DY5 1QA
United Kingdom.

Telephone 01384 489700
Facsimile 01384 489707
Email marketing@airbloc.co.uk
Website www.airbloc.co.uk
Technical Support www.s-i-d.co.uk

An AmbiRad Group brand

AIRBLOC
ENERGY SAVING AIR CURTAINS