**MIXING CHAMBERS
KM**



TABLE OF CONTENT

■ GENERAL CHARACTERISTICS	3
■ CONSTRUCTION	4
■ DIMENSIONS	5
■ TECHNICAL DATA	5
■ RANGE OF AIR STREAM	7
■ ACCESSORIES	8
■ INSTALLATION AND MOUNTING POSSIBILITIES	8
■ REGULATION	11
■ CONTROL ELEMENTS	12
■ BMS PROGRAMMING	13
■ FLOWAIR SYSTEM	13
■ CONNECTION DIAGRAMS	14
■ VELOCITY OF AIR FLOW	15
■ ROOF FANS UVO	16
■ ACCESSORIES - ROOF FANS UVO	17
■ HEATING CAPACITIES	19

GENERAL CHARACTERISTICS



Mixing chambers **KM**

Heating capacity [kW]	0,5 - 82,2
Air flow [m ³ /h]	450 - 3700
Weight [kg]	25,9 - 57,9
Casing	steel + aluminum + plastic
Colour	silver

Range of heating power at given parameters:
min. – I step of fan, 100% fresh air supply, temperature of heating medium 40/30°C, air temperature at the supply to the device 20°C;
max. – III step of fan, 100% fresh air supply, temperature of heating medium 120/90°C, air temperature at the supply to the device 0°C;

APPLICATION

KM mixing chamber is designed to work with fan heaters LEO. It enables delivery of fresh (outside) air into the room. KM with LEO fan heater, UVO roof fans and KM REGULATION set create complete mechanical ventilation system which can be applied in medium and big cubature buildings like industrial halls, warehouses, commercial halls, etc.

AVAILABLE TYPES OF UNITS

- **KM S**
Mixing chamber made of galvanized steel dedicated for LEO S
- **KM L**
Mixing chamber made of galvanized steel dedicated for LEO L
- **KM XL**
Mixing chamber made of galvanized steel dedicated for LEO XL
- It is possible to make a mixing chamber made of stainless steel (INOX) and connect KM to the LEO fan heater in a steel casing.

LEO



KM

+



More information about fan heaters LEO check in LEO catalogue.

CONSTRUCTION

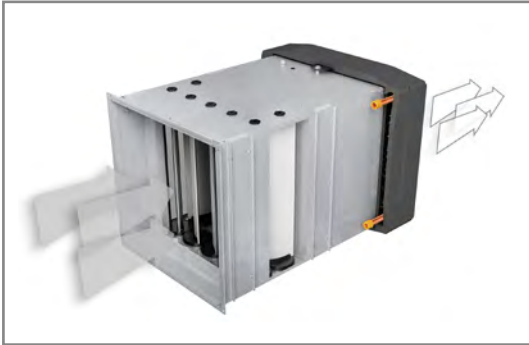

AIR FILTER

Mixing chamber is equipped with EU3 class cassette filter, which cleans the air supplied to the room of solid particles like big pollens, thick metallurgy dust etc. Filter module can be installed in two ways. It is possible to filter only outdoor air or outdoor and recirculated air.

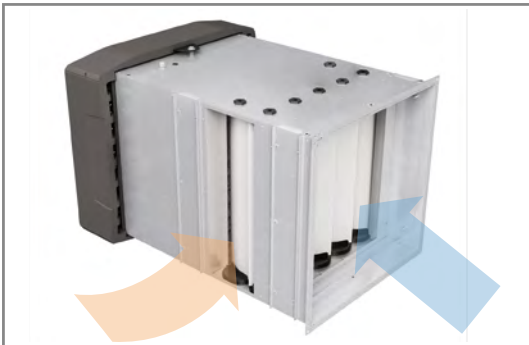

RECIRCULATION

Mixing chamber is equipped with inlets of fresh and recirculated air. Volume of fresh air can be smoothly changed in 0-100% range due to stepless regulation of dampers opening.



DESIGN

Mixing chamber is specially designed for LEO fan heaters. The main objective of the design process was to create a compact, aesthetic unit. The other objective was to obtain as low weight and dimensions as possible, maintaining the best technical parameters.



KM REGULATION

The KM Regulation System consists of: T-box controller + KM automation set. The KM automation set is a complete supply, control and protection system for one water heater cooperating with the mixing chamber. The KM automation set includes the DRV KM control module, proportional mixing chamber damper actuator, 3-way valve with 3-point actuator, 4 temperature sensors.

DIMENSIONS

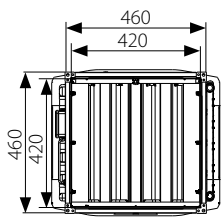

LEO S + KM S

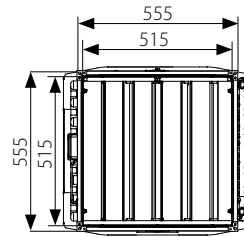
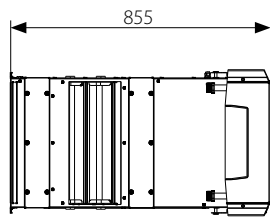

LEO L + KM L

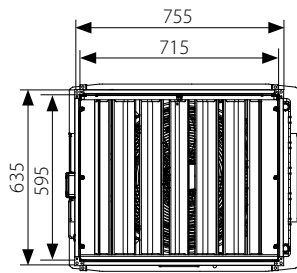

LEO XL + KM XL

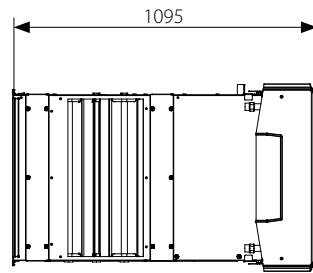

■ For CAD drawings, Revit files and documentation for all available types of units visit www.flowair.com



TECHNICAL DATA

Fan heaters LEO S with mixing chamber KM S

	LEO S1 + KM S			LEO S2 + KM S			LEO S3 + KM S		
	III	II	I	III	II	I	III	II	I
Fan step	III	II	I	III	II	I	III	II	I
Max. air flow [m ³ /h]	1200	850	550	1100	800	500	1000	700	450
Power supply [V/Hz]	230/50			230/50			230/50		
Max. current consumption [A]	0,5	0,4	0,3	0,6	0,4	0,3	0,6	0,4	0,3
Max. power consumption [W]	120	90	70	130	90	70	130	90	70
IP/Insulation class	54/F			54/F			54/F		
Max. acoustic pressure level [dB(A)] ⁽¹⁾	56,3	50,7	43,9	56,3	50,7	43,9	56,3	50,7	43,9
Max. acoustic power level [dB(A)] ⁽²⁾	71,4	65,8	59,0	71,4	65,8	59,0	71,4	65,8	59,0
Range of horizontal isothermal air stream [m] ⁽³⁾	8,0	6,0	4,0	7,5	5,5	3,5	7,0	5,0	3,0
Range of vertical nonisothermal air stream [m] ⁽⁴⁾	3,4	2,6	1,8	3,2	2,4	1,7	2,9	2,2	1,5
Max. heating water temperature [°C]	120			120			120		
Max. operating pressure [MPa]	1,6			1,6			1,6		
Connection ["]	½			½			½		
Max. working temperature [°C]	60			60			60		
Weight [kg]	25,9			26,8			27,9		
Weight of unit filled with water [kg]	26,6			28,0			29,3		

⁽¹⁾ Acoustic pressure level at the distance of 5 m from the unit, in the room of medium capability of sound absorption and cubature of 1500 m³

⁽²⁾ According to PN-EN ISO3744

⁽³⁾ Range of horizontal isothermal air stream, at 0,5 m/s velocity limit

⁽⁴⁾ Range of vertical nonisothermal air stream at ΔT = 5°C, at 0,5 m/s velocity limit

TECHNICAL DATA

Fan heaters **LEO L** with mixing chamber **KM L**

Fan step	LEO L1 + KM L			LEO L2 + KM L			LEO L3 + KM L		
	III	II	I	III	II	I	III	II	I
Max. air flow [m ³ /h]	2600	1600	800	2400	1500	700	2250	1350	600
Power supply [V/Hz]	230/50			230/50			230/50		
Max. current consumption [A]	1,4	1,2	0,6	1,5	1,2	0,6	1,5	1,2	0,6
Max. power consumption [W]	330	240	120	340	240	120	340	240	120
IP/Insulation class	54/F			54/F			54/F		
Max. acoustic pressure level [dB(A)] ⁽¹⁾	64,1	54,5	42,1	64,1	54,5	42,1	64,1	54,5	42,1
Max. acoustic power level [dB(A)] ⁽²⁾	79,2	69,6	57,2	79,2	69,6	57,2	79,2	69,6	57,2
Range of horizontal isothermal air stream [m] ⁽³⁾	14,5	9,0	4,5	13,5	8,5	4,0	12,5	7,5	3,5
Range of vertical nonisothermal air stream [m] ⁽⁴⁾	5,3	3,5	2,0	5,0	3,3	1,8	4,7	3,0	1,6
Max. heating water temperature [°C]	120			120			120		
Max. operating pressure [MPa]	1,6			1,6			1,6		
Connection ["]	¾			¾			¾		
Max. working temperature [°C]	60			60			60		
Weight [kg]	34,3			35,5			37,8		
Weight of unit filled with water [kg]	35,3			37,5			40,5		

Fan heaters **LEO XL** with mixing chamber **KM XL**

Fan step	LEO XL2 + KM XL			LEO XL3 + KM XL		
	III	II	I	III	II	I
Max. air flow [m ³ /h]	3700	2700	1600	3100	2200	1300
Power supply [V/Hz]	230/50			230/50		
Max. current consumption [A]	2,3	1,8	1,4	2,4	1,8	1,4
Max. power consumption [W]	520	370	270	550	370	270
IP/Insulation class	54/F			54/F		
Max. acoustic pressure level [dB(A)] ⁽¹⁾	67,5	61,1	52,3	67,5	61,1	52,3
Max. acoustic power level [dB(A)] ⁽²⁾	82,6	76,2	67,8	82,6	76,2	67,8
Range of horizontal isothermal air stream [m] ⁽³⁾	16,5	12,0	7,0	14,0	10,0	6,0
Range of vertical nonisothermal air stream [m] ⁽⁴⁾	5,8	4,4	2,9	4,9	3,7	2,4
Max. heating water temperature [°C]	120			120		
Max. operating pressure [MPa]	1,6			1,6		
Connection ["]	¾			¾		
Max. working temperature [°C]	60			60		
Weight [kg]	53,6			57,9		
Weight of unit filled with water [kg]	56,3			62,0		

⁽¹⁾ Acoustic pressure level at the distance of 5 m from the unit, in the room of medium capability of sound absorption and cubature of 1500 m³

⁽²⁾ According to PN-EN ISO3744

⁽³⁾ Range of horizontal isothermal air stream, at 0,5 m/s velocity limit

⁽⁴⁾ Range of vertical nonisothermal air stream at $\Delta T = 5^{\circ}\text{C}$, at 0,5 m/s velocity limit

RANGES

HORIZONTAL RANGE OF AIR STREAM – isothermal

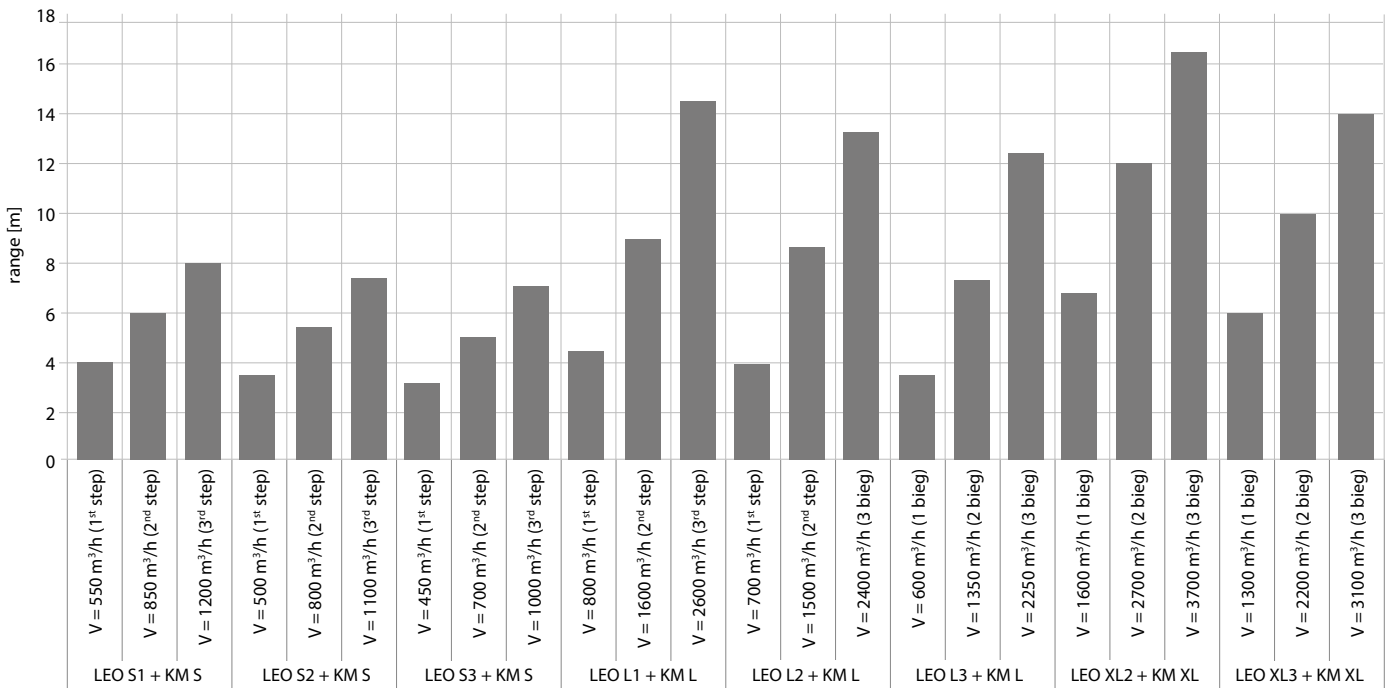

Range of horizontal isothermal air stream, at 0,5 m/s velocity limit.

V – Max. air flow

VERTICAL RANGE OF AIR STREAM – non-isothermal

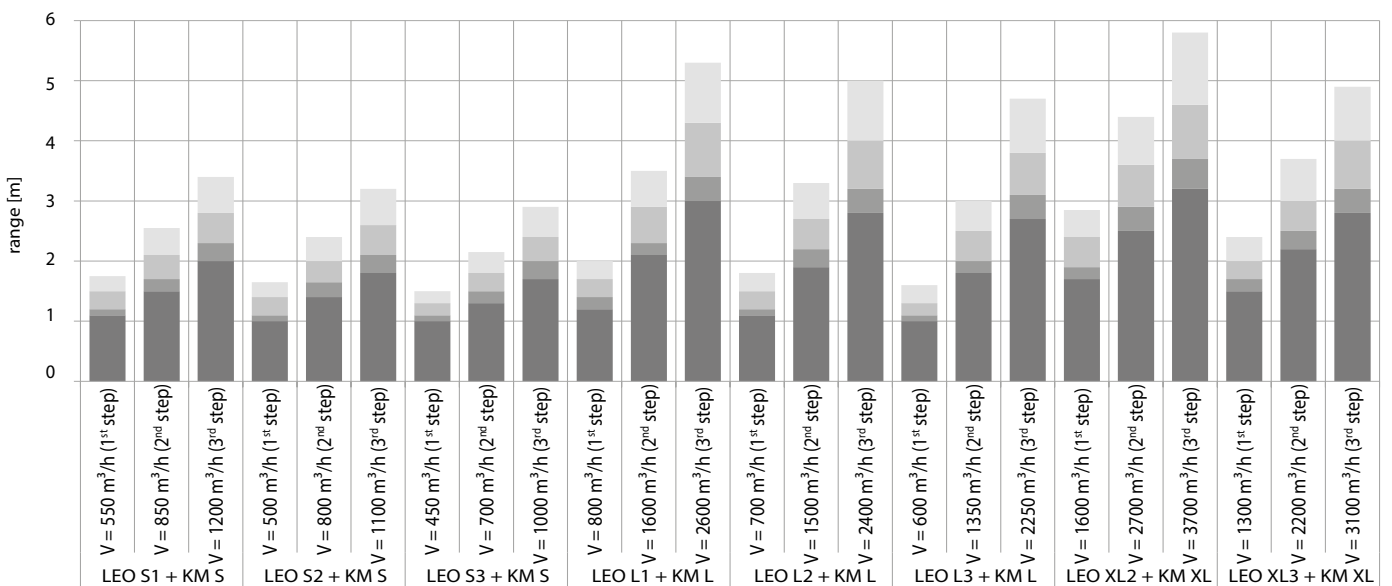

V – air flow

Δ5°C Δ10°C Δ20°C Δ30°C

ACCESSORIES

WALL ACCESSORIES

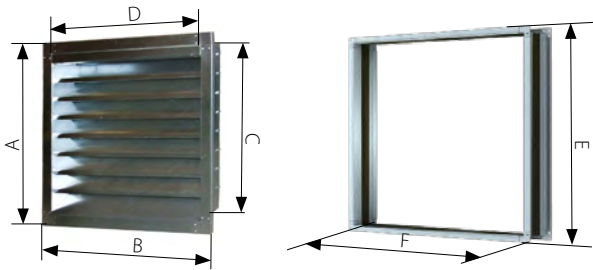

WALL AIR INTAKE

It is equipped with a galvanized net and permanent shutters protecting air inlet against atmospheric precipitation.

FLEXIBLE CONNECTION

It enables easier mounting of the device to the air intake or to extension duct installation and prevents the transmission of possible vibrations. Flexible connection shall be used when mounting the mixing chamber under the ceiling on installation pins.

	S	L	XL
A [mm]	500	595	675
B [mm]	500	595	795
C [mm]	420	515	595
D [mm]	420	515	715
E [mm]	460	555	635
F [mm]	460	555	755
Air intake weight [kg]	3,3	5,0	8,2
Flexible connection weight [kg]	2,2	2,6	3,0

ROOF ACCESSORIES

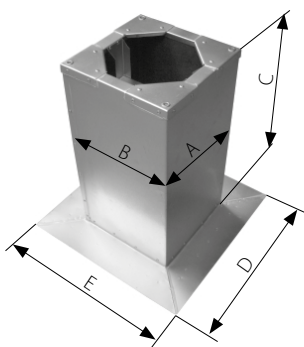
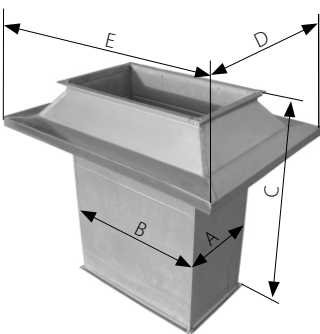
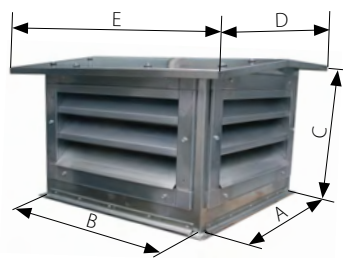

ROOF AIR INTAKE

It is equipped with a galvanized net and permanent shutters which protect the air intake against atmospheric precipitation.

ROOF BASE

It is used in places where the ventilation system passes through the roof surface. The streamlined shape of the base enables water and snow removal.

ROOF CURB

It is used to level up the roof surface. Roof bases can be mounted on the roof curbs.

Roof air intake	KM S	KM L	KM XL	Roof base	KM S	KM L	KM XL
A [mm]	420	515	595	A [mm]	420	515	595
B [mm]	420	515	715	B [mm]	420	515	715
C [mm]	500	500	500	C [mm]	1000	1000	1000
D [mm]	500	595	675	D [mm]	780	875	955
E [mm]	500	595	795	E [mm]	780	875	1075
Weight [kg]	22	32	38	Weight [kg]	23	26	32

Roof curb	KM S	KM L	KM XL
A [mm]	700	800	875
B [mm]	700	800	995
C [mm]	min. 300	min. 300	min. 300
D [mm]	900	1000	1075
E [mm]	900	1000	1195
Weight [kg] ⁽¹⁾	14	16	18

⁽¹⁾ depending on the angle of roof slope

INSTALLATION AND MOUNTING POSSIBILITIES

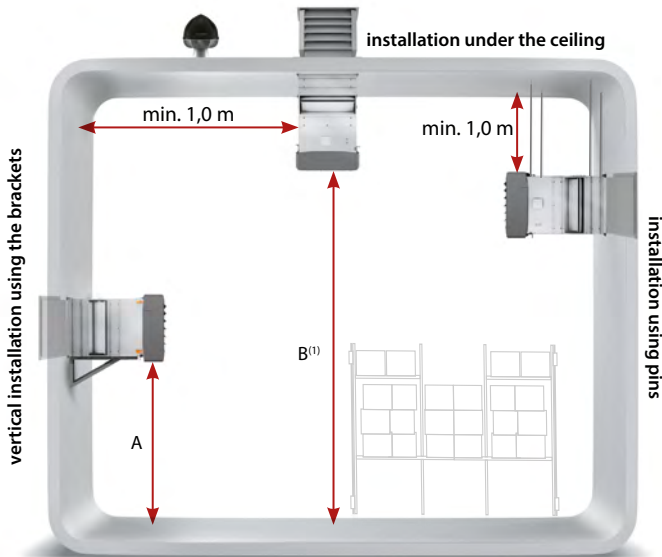

LEO + KM + UVO



Mounting bracket allows for easy and aesthetic mounting on the walls

⁽¹⁾ for air blades installed vertically. When mounting the device under the ceiling please note the proper nonisothermal air stream range.

RECOMMENDED INSTALLATION DISTANCE [m]

	LEO S1 + KM S	LEO S2 + KM S	LEO S3 + KM S	LEO L1 + KM L	LEO L2 + KM L	LEO L3 + KM L	LEO XL2 + KM XL	LEO XL3 + KM XL
A	max. 3,0	max. 3,0	max. 3,0	2,5 – 5,0	2,5 – 5,0	2,5 – 5,0	2,5 – 5,0	2,5 – 5,0
B	2,5 – 4,5	2,5 – 4,0	2,5 – 4,0	2,5 – 6,5	2,5 – 6,0	2,5 – 5,5	2,5 – 7,0	2,5 – 6,0

FILTERS

It is possible to filter only outdoor air or both - outdoor and recirculated air.

It is possible to mount filter on left or right side.



I MOUNTING HANDLES

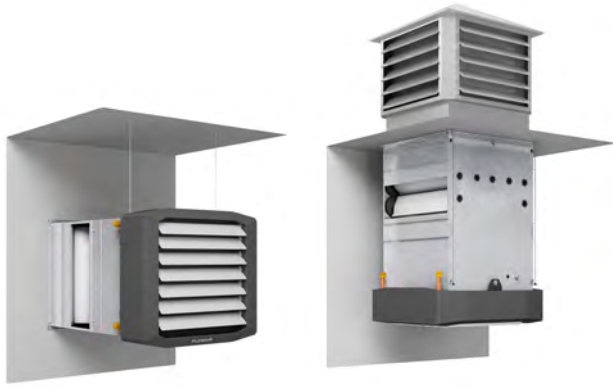

The heating and ventilation units LEO + KM can be installed on the walls or under the ceiling. The basic equipment of the unit consists of the handles for installation under the ceiling using pins.

I INSTALLATION TO WALL

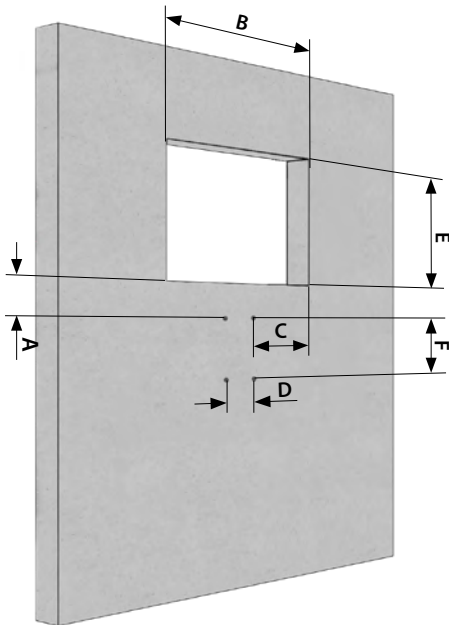

	KM S	KM L	KM XL
A	82	82	82
B	425	515	720
C	170	215	315
D	85	85	85
E	425	515	600
F	130	130	130

I CEILING MOUNTING

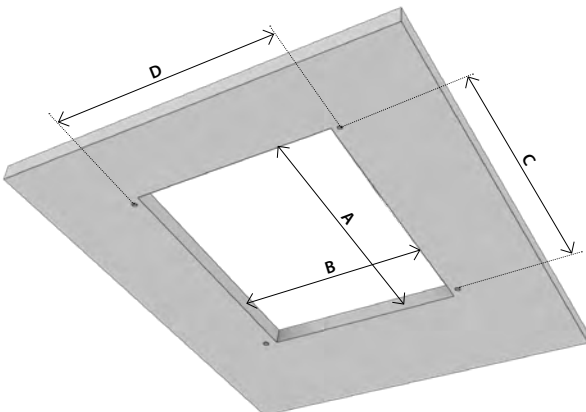

	KM S	KM L	KM XL
A	425	515	720
B	425	515	600
C	400	495	695
D	480	575	655

INSTALLATION TIPS

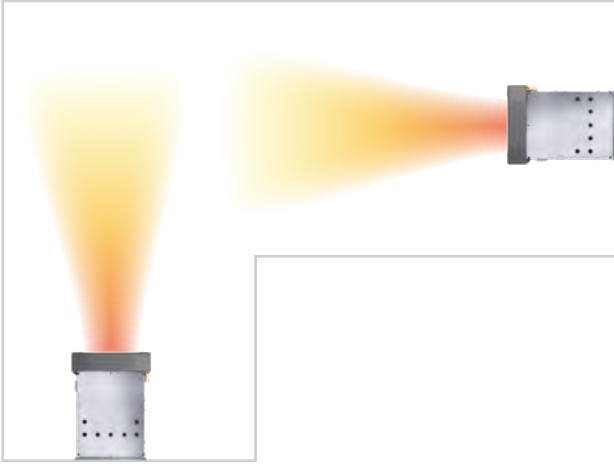

Steady air distribution should be provided in the entire room.

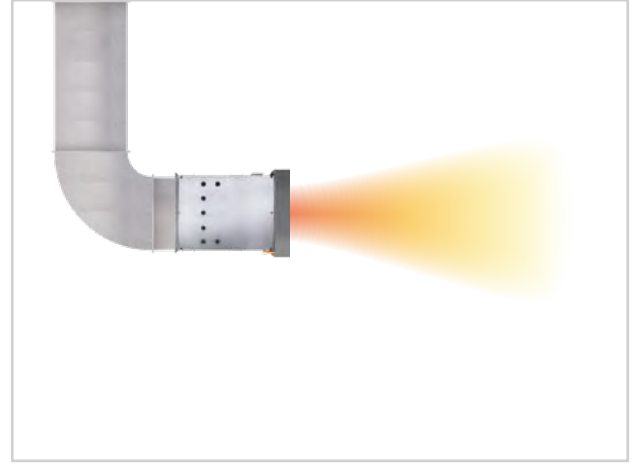

It is not recommended to supply fresh air through ducts in which additional local pressure losses occur. This can cause a significant drop in airflow.

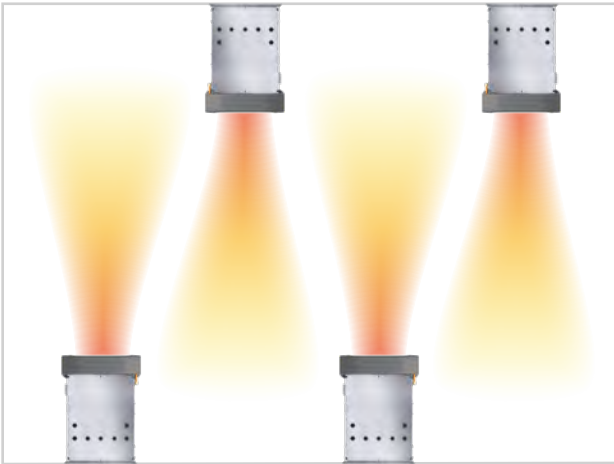

Heaters installed on the opposite walls should be overlapped.

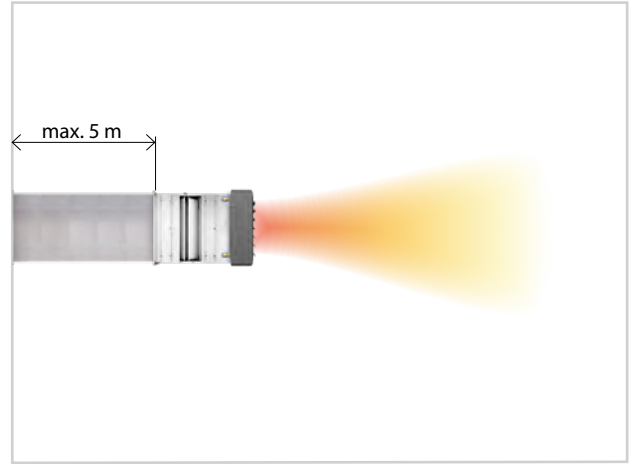

It is allowed to deliver fresh air into the device with straight channels.

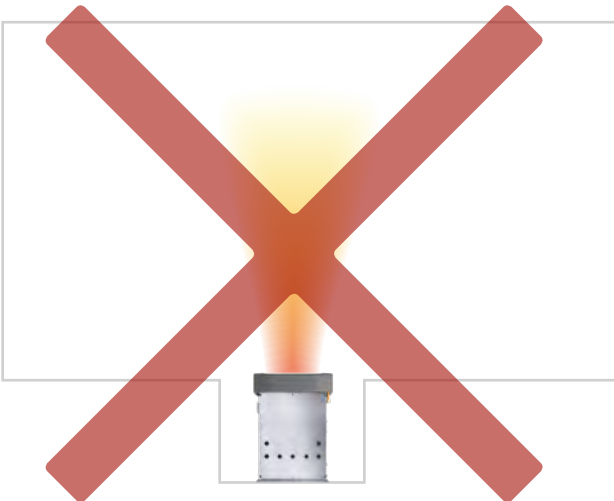

Heaters should be installed in a way that ensures free air supply around the unit.

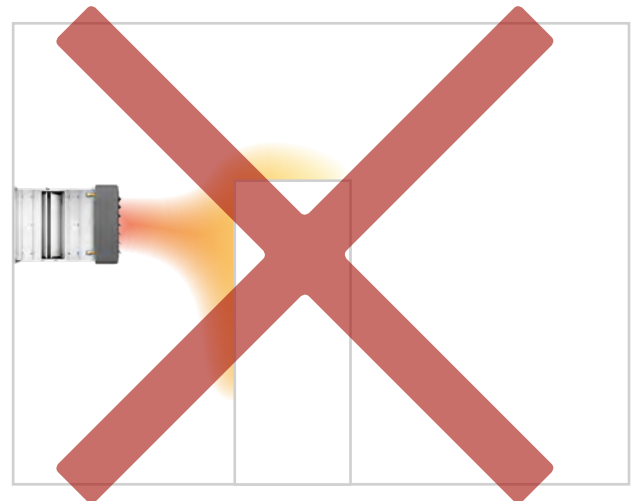

Big objects must not limit the air stream of the heater.

CONTROL SYSTEM

AUTOMATION SET

ELEMENTS OF KM REGULATION SET

- DRV KM control module,
- air dampers actuator 0-10V,
- 3-way valve with 3-point actuator,
- outside air temperature sensor,
- recirculated air temperature sensor,
- supplied air temperature sensor,
- heating medium temperature sensor.

BASIC FUNCTIONS

- 3-step fan speed regulation,
- smooth regulation of supplied air temperature,
- balance, overpressure or underpressure in relation to roof fans,
- room antifreeze protection,
- water heat exchanger antifreeze protection,
- weekly programmer,
- integration with FLOWAIR SYSTEM - possibility of control up to 31 units in SYSTEM via 1 controller,
- possibility of connection to BMS,
- possibility of connection to gas detector box,
- regulation of dampers opening in relation to outside temperature,
- monitoring of filter clogging level if the filter pressure switch is added (as an accessory)

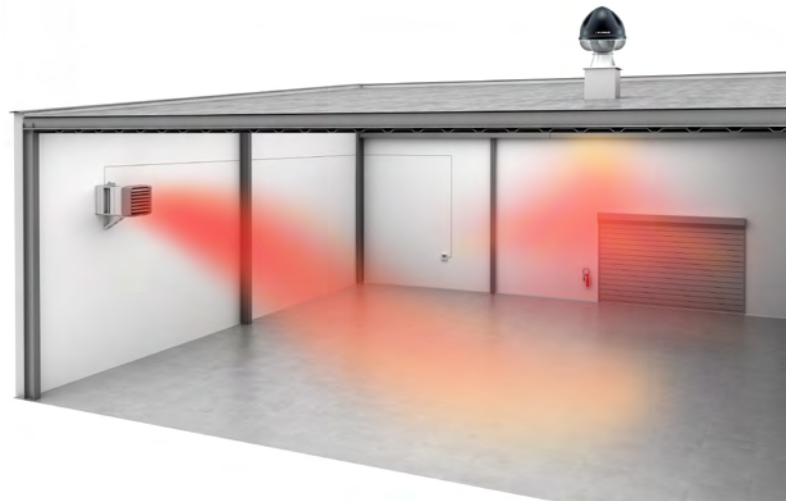

WATER HEAT EXCHANGER ANTIFREEZE PROTECTION

The automation set has 4 temperature sensors that examine the operating states of the device in real time. In case of too low temperature at air outlet just after water exchanger or too low heating medium temperature, the unit switches to antifreeze mode. In this mode, fresh air dampers stay closed, the SRX valve opens (automation equipment) causing the heating medium flow through the device and switching off unit's fan. This lasts until the operating conditions improve, then the device returns to normal operation mode according to schedule.

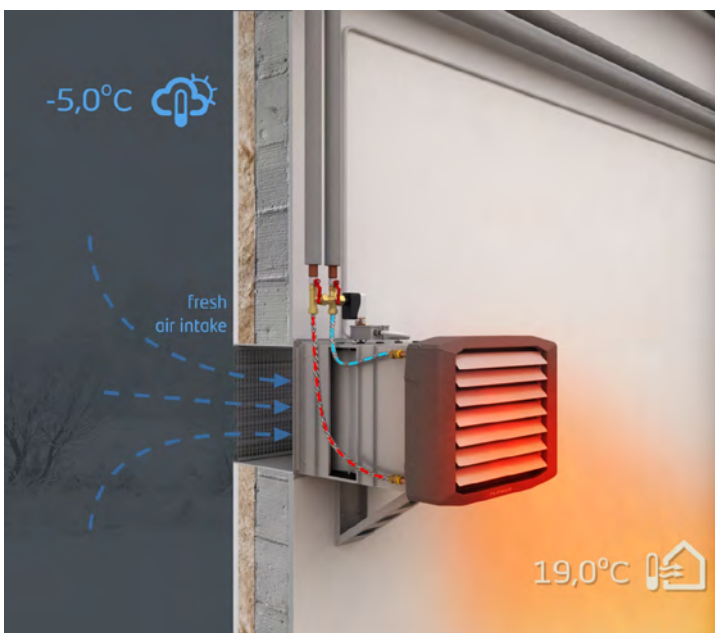

FIND OUT MORE!

constant supply air temperature and dampers setting according to outdoor air temperature









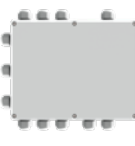

FIND OUT MORE!

balance with roof fans

CONTROL ELEMENTS

KM REGULATION

Category	Symbol	Picture	Technical data
Controller	T-box intelligent controller with touch screen		Protection degree: IP20 Power supply: 24 VDC Operating temperature range: 0 ... +60°C Temperature setting range: +5 ... +45°C Max. cross-section area of the wire: 2,5 mm ²
	DRV KM control module		Protection degree: IP54 Power supply: 230 V / 50 Hz Dimensions: 285x235x85 mm Operating temperature range: 0 ... +60°C Number of connected units: 1 Max. cross-section area of the wire: 2,5 mm ²
	SP 0-10 V 4 Nm damper actuator with spring return with continuous operation, included with KM S and KM L automation set		Protection degree: IP54 Power supply: 24 VAC 50/60 Hz, 24 VDC Operating temperature range: -30°C ... +50°C Wires: 4x0,75 mm ²
	SP 0-10 V 10 Nm damper actuator with spring return with continuous operation, included with KM XL automation set		Protection degree: IP54 Power supply: 24 VAC 50/60 Hz, 24 VDC Operating temperature range: -30°C ... +50°C Wires: 4x0,75 mm ²
set of KM automation	SRX3d-½ three-way valve ½" with 3-point actuator in set with KM S automation		Protection degree: IP40 Power supply: 230 VAC Max. temp. of the heating medium: 120°C Max. operating pressure: 1,0 MPa Kvs: 4,0 m ³ /h Connection: 1/2" Run time: 140 s
	SRX3d-¾ three-way valve ¾" with 3-point actuator in set with KM L automation		Protection degree: IP40 Power supply: 230 VAC Max. temp. of the heating medium: 120°C Max. operating pressure: 1,0 MPa Kvs: 6,3 m ³ /h Connection: 3/4" Run time: 140 s
	SRX3d-1 three-way valve 1" with 3-point actuator in set with KM XL automation		Protection degree: IP40 Power supply: 230 VAC Max. temp. of the heating medium: 120°C Max. operating pressure: 1,0 MPa Kvs: 10,0 m ³ /h Connection: 1" Run time: 140 s
	PT-1000 heating medium temperature sensor		Protection degree: IP66 Operating temperature range: -40 ... +150°C
	PT-1000 • outside air temperature sensor, • recirculated air temperature sensor, • supplied air temperature sensor,		Protection degree: IP66 Operating temperature range: -40 ... +150°C

BMS PROGRAMMING

FOR T-box REGULATION

Connection of devices to the BMS (Building Management System) is possible in two ways: through the T-box controller (Version 1) or through the DRV KM control module (Version 2).

VERSION 1

T-box controller enables connection of the system to BMS system. When monitoring devices via the T-box controller with one address in the BMS, it is possible to independently monitor the operation of up to 31 devices.

VERSION 2

The DRV KM control modules enable connection to the BMS system. It is possible to set up to 31 addresses. Setting the address for each device separately allows independent reading and saving of the work parameters of each device.

Communication parameters:

Name	T-box setting
Physical layer	RS485
Protocol	MODBUS-RTU
Transmission speed [bps]	9600 to 230400
Parity	Even
Number of data bits	8
Number of stop bits	1

Communication parameters:

Name	DRV KM
Physical layer	RS485
Protocol	MODBUS-RTU
Transmission speed [bps]	38400
Parity	Even
Number of data bits	8
Number of stop bits	1

FLOWAIR SYSTEM

FLOWAIR SYSTEM is an intelligent solution which integrates the devices into a system with only one controller.

T-box offers many functions necessary for effective management of a heating-ventilation system. These functions were previously reserved for an extensive Building Management System (BMS).



CONNECTION DIAGRAMS

KM REGULATION

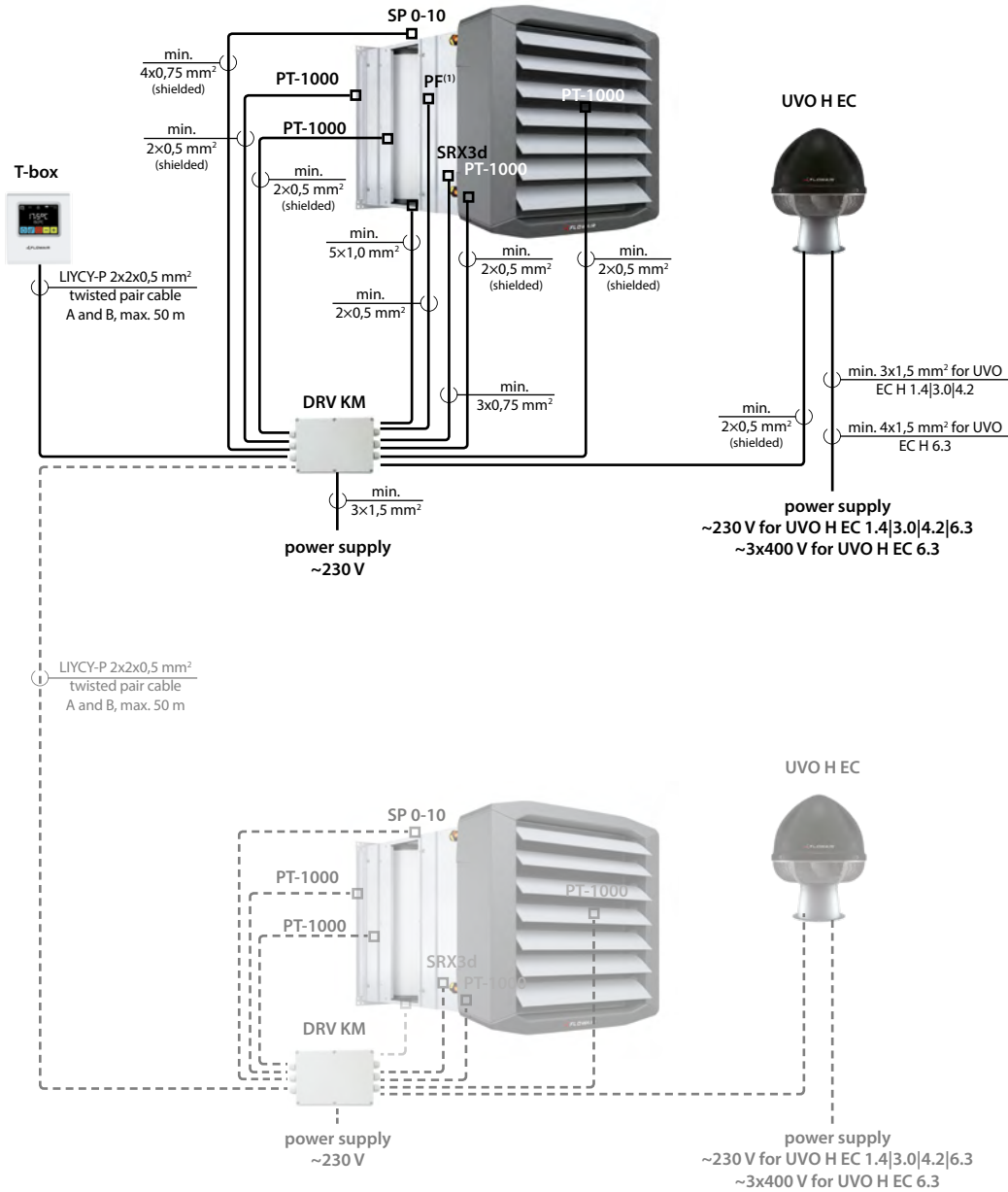

max. 31 units
compatible
with FLOWAIR SYSTEM

⁽¹⁾ filter pressure switch - optional

VELOCITY OF AIR FLOW

LEO S1 + KM S

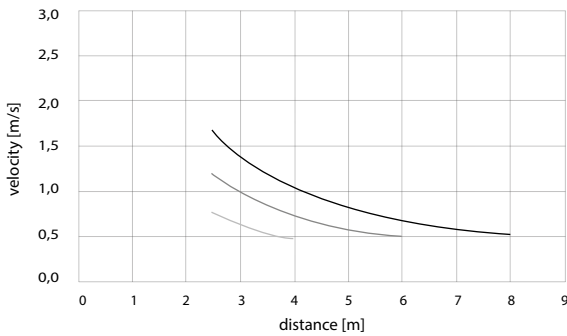

LEO S2 + KM S

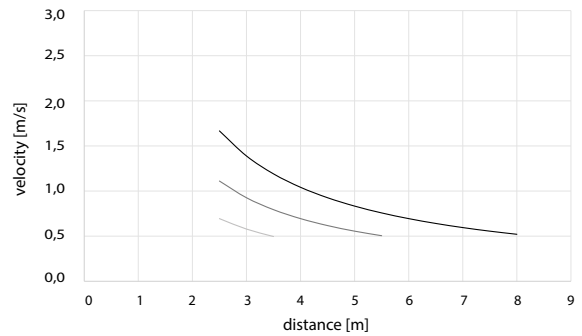

LEO S3 + KM S

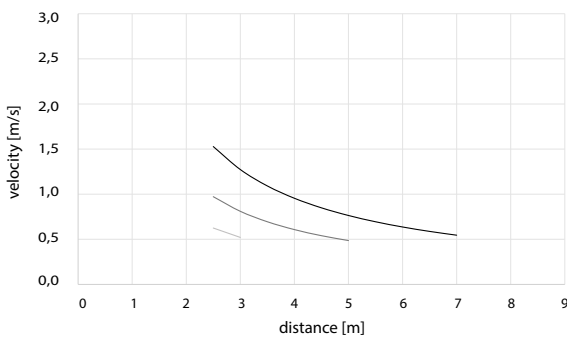

LEO L1 + KM L

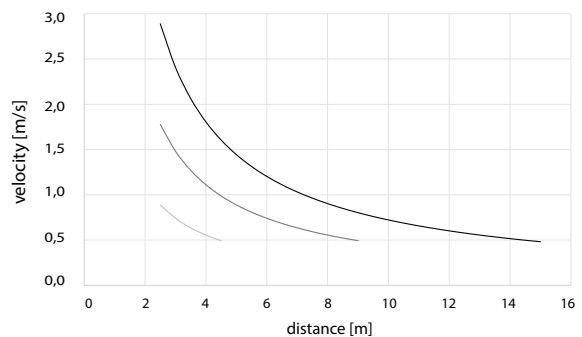

LEO L2 + KM L

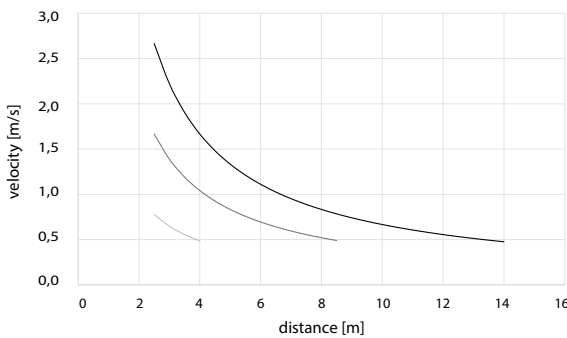

LEO L3 + KM L

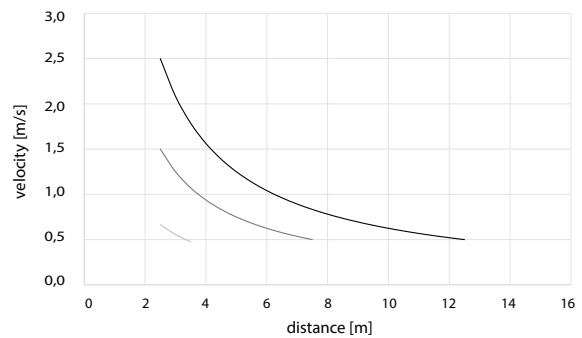

LEO XL2 + KM XL

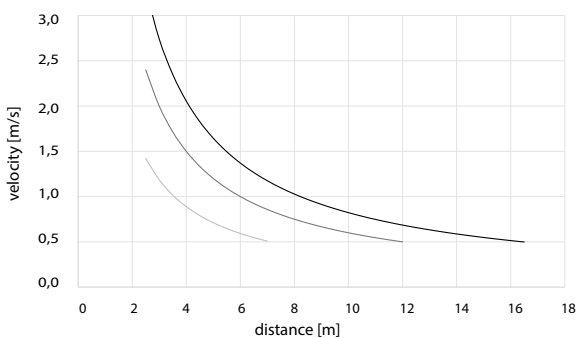

LEO XL3 + KM XL

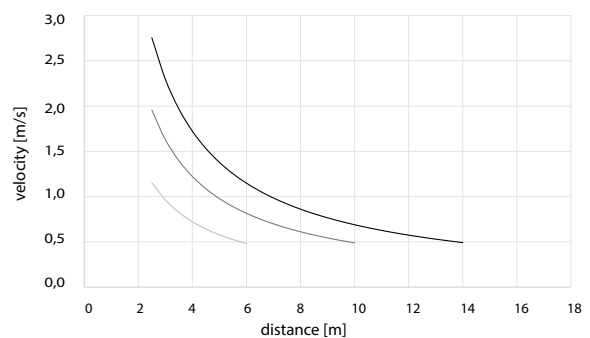

- 1st step
- 2nd step
- 3rd step

UVO ROOF FANS

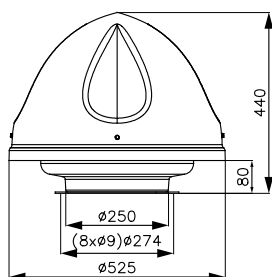

UVO H 1.4 EC

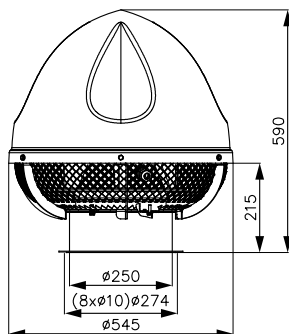

UVO H 3.0 EC

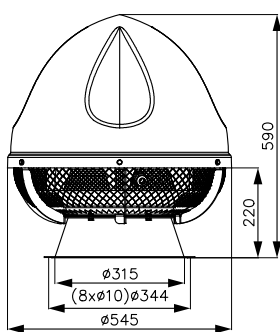

UVO H 4.2 EC

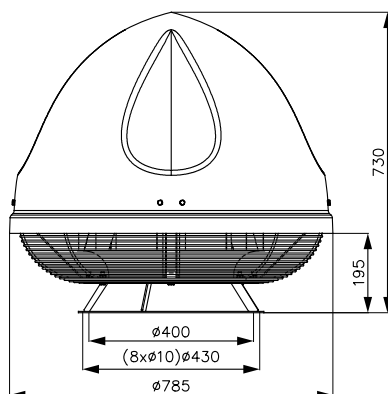

UVO H 6.3 EC

UVO H EC fans are equipped with electronically commutated (EC) motors, controlled by a 0-10 V signal. Thanks to such a construction it is possible to regulate their performance without applying additional frequency inverters.

■ For CAD drawings and documentation visit www.flowair.com



TECHNICAL DATA

UVO roof fans

		UVO H 1.4 EC	UVO H 3.0 EC	UVO H 4.2 EC	UVO H 6.3 EC
Synchronous rotations [min ⁻¹]		1925	2200	1430	1450
Power supply [V]		230	230	230	3x400
Max. current consumption [A]		1,3	1,45	1,5	1,7
Max. power consumption [W]		275	320	330	1000
IP		44	44	44	44
Max. air flow [m ³ /h]		1400	3000	4200	6300
Max. vacuum pressure [Pa]		460	620	480	530
Weight of unit [kg]		12,3	19,4	22,1	47,6
Max. acoustic pressure level [dB(A)]	inlet ⁽¹⁾				
	5 m	52,5	57,3	55,7	58,2
	outlet ⁽²⁾				
	1 m	64,5	71,6	69,4	74,2
	5 m	50,5	57,6	55,4	60,2

⁽¹⁾ Acoustic pressure level at room inlet at the distance of 5 m from the unit mounted on a damping roof base, in the room of medium capability of sound absorption and 1500 m³ of cubature.

⁽²⁾ Acoustic pressure level at room outlet at the distance of 1 m or 5 m from the unit mounted above the reflecting surface.

UVO ROOF FANS

FLOW CHARACTERISTICS

UVO H 1.4 EC

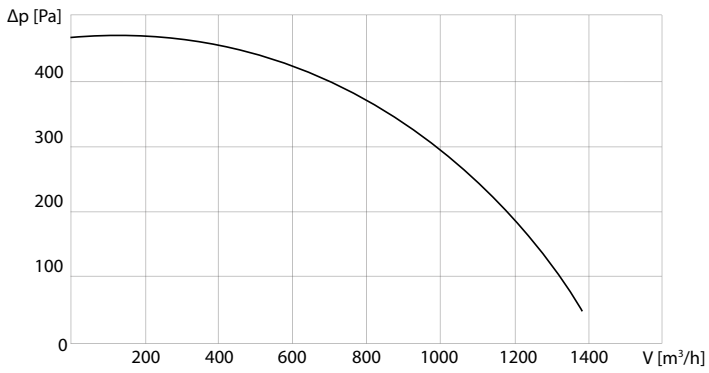

UVO H 3.0 EC

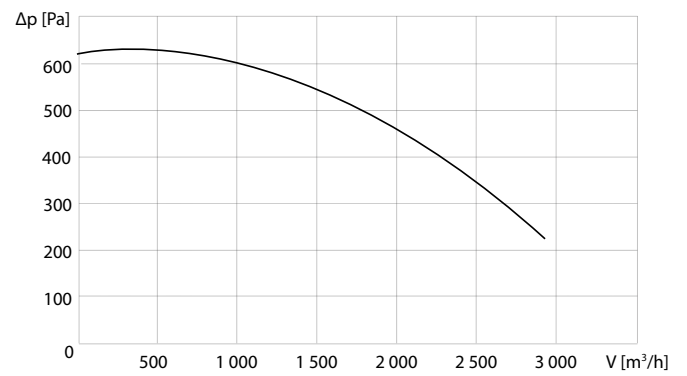

UVO H 4.2 EC

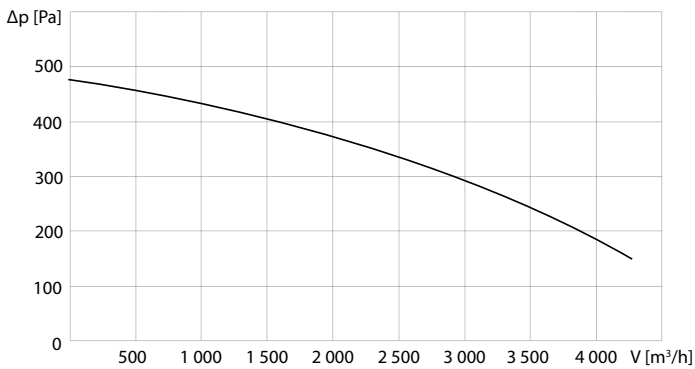

UVO H 6.3 EC

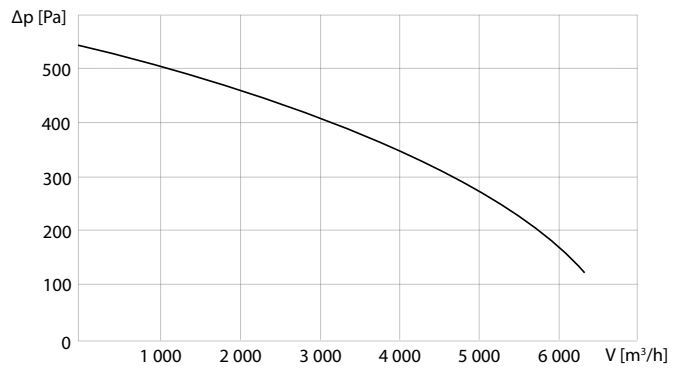

ACCESSORIES – UVO ROOF FANS

ROOF BASES

HPDT - SOUND ABSORBING ROOF BASE WITH ROOF CURB FOR FLAT ROOFS

Material: galvanized steel

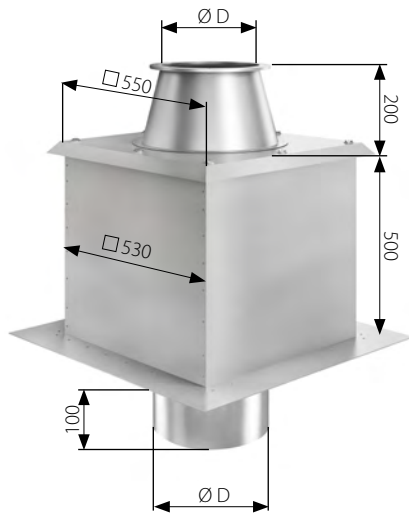

	D [mm]	WEIGHT [kg]
UVO H 1.4 EC	250	20,0
UVO H 3.0 EC	250	20,0
UVO H 4.2 EC	315	21,0
UVO H 6.3 EC	400	22,0

HPDTS - SOUND ABSORBING ROOF BASE WITH ROOF CURB FOR PITCHED ROOFS

Material: galvanized steel

Angle α – the angle of cutting the base to fit the slope of the roof, shall be indicated when submitting the order

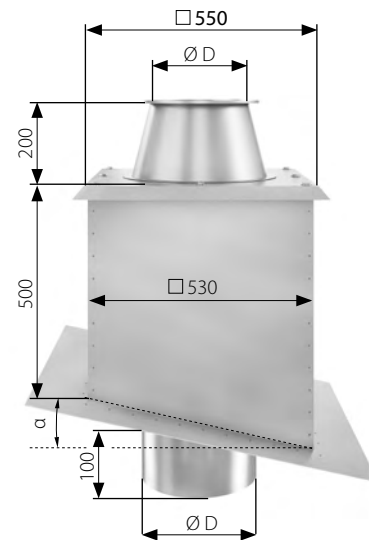

	D [mm]	WEIGHT [kg]
UVO H 1.4 EC	250	20,0
UVO H 3.0 EC	250	20,0
UVO H 4.2 EC	315	21,0
UVO H 6.3 EC	400	22,0

HPD - ROOF BASE

Material: galvanized steel

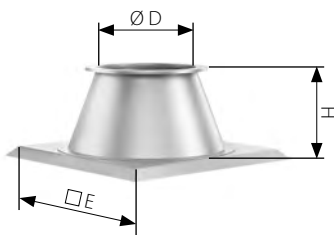

	D [mm]	E [mm]	H [mm]	WEIGHT [kg]
UVO H 1.4 EC	250	455	198	3,8
UVO H 3.0 EC	250	455	198	3,8
UVO H 4.2 EC	315	544	198	4,2
UVO H 6.3 EC	400	656	198	6,4

HPDR - ROOF BASE WITH SPIRO

Material: galvanized steel

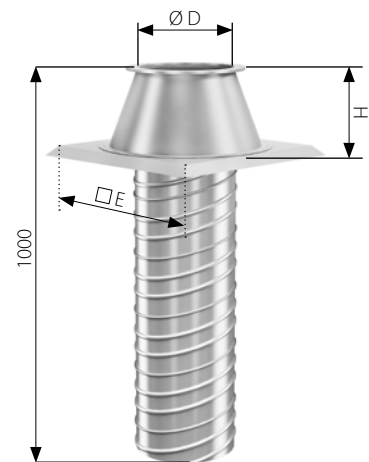

	D [mm]	E [mm]	H [mm]	WEIGHT [kg]
UVO H 1.4 EC	250	455	198	7,3
UVO H 3.0 EC	250	455	198	7,3
UVO H 4.2 EC	315	544	198	9,0
UVO H 6.3 EC	400	656	198	13,0

ACCESSORIES - ROOF FANS UVO

ROOF BASES

CB - ROOF CURB FOR SLOPED ROOFS

Material: galvanized steel

It is used for mounting HPD and HPDr roof bases to pitched roofs. The angle of the roof curb cutting shall be the same as the angle of the roof slope.

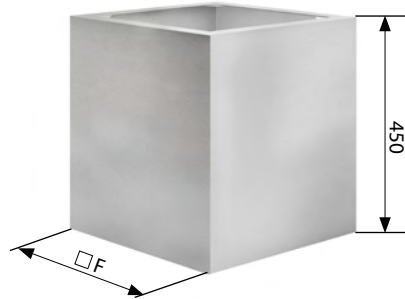

	F [mm]	WEIGHT [kg]
UVO H 1.4 EC	430	6,6
UVO H 3.0 EC	430	6,6
UVO H 4.2 EC	530	10,2
UVO H 6.3 EC	616	11,2

SOUND ABSORBING HT

HT-1.0 SOUND ABSORBING DUCT

Length (L): 1,0 m

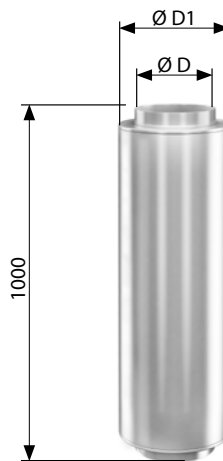

	D [mm]	D ₁ [mm]	WEIGHT [kg]
UVO H 1.4 EC	250	350	13,7
UVO H 3.0 EC	350	350	13,7
UVO H 4.2 EC	315	415	17,3
UVO H 6.3 EC	400	500	22,0

PZ - RETURN DAMPER

Material: galvanized steel

	D [mm]	L ₁ [mm]	WEIGHT [kg]
UVO H 1.4 EC	250	125	0,6
UVO H 3.0 EC	250	125	0,6
UVO H 4.2 EC	315	125	0,8
UVO H 6.3 EC	400	200	1,1

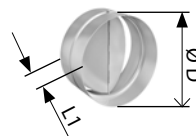

HEATING CAPACITIES

Tw1 / Tw2 = 120/90°C					Tw1 / Tw2 = 90/70°C					Tw1 / Tw2 = 70/50°C					Tw1 / Tw2 = 60/40°C					Tw1 / Tw2 = 40/30°C				
Tp1	PT	Qw	Δpw	Tp2	Tp1	PT	Qw	Δpw	Tp2	Tp1	PT	Qw	Δpw	Tp2	Tp1	PT	Qw	Δpw	Tp2	Tp1	PT	Qw	Δpw	Tp2
[°C]	[kW]	[l/h]	[kPa]	[°C]	[°C]	[kW]	[l/h]	[kPa]	[°C]	[°C]	[kW]	[l/h]	[kPa]	[°C]	[°C]	[kW]	[l/h]	[kPa]	[°C]	[°C]	[kW]	[l/h]	[kPa]	[°C]
LEO S1 + KM S																								
3rd fan step: V = 1200 m³/h																								
-25,0			*		-25,0					-25,0					-25,0					-25,0				
-20,0	11,0	326	1,3	7,0	-20,0			*		-20,0				*	-20,0					-20,0				
-15,0	10,5	313	1,2	11,0	-15,0	8,3	368	1,8	5,5	-15,0				*	-15,0			*		-15,0			*	
-10,0	10,1	299	1,2	15,0	-10,0	7,9	348	1,6	9,5	-10,0					-10,0					-10,0				
-5,0	9,6	286	1,1	19,0	-5,0	7,4	328	1,5	13,5	-5,0	5,2	229	0,8	8,0	-5,0					-5,0				
0,0	9,2	273	1,0	22,5	0,0	7,0	307	1,3	17,0	0,0	4,8	208	0,7	11,5	0,0	3,5	153	0,4	8,5	0,0	2,6	228	0,9	6,5
5,0	8,7	259	0,9	26,5	5,0	6,5	287	1,1	21,0	5,0	4,3	186	0,6	15,5	5,0	3,0	129	0,3	12,5	5,0	2,1	182	0,6	10,0
10,0	8,3	246	0,8	30,0	10,0	6,0	266	1,0	25,0	10,0	3,8	164	0,5	19,0	10,0	2,3	100	0,2	15,5	10,0	1,5	125	0,3	13,5
15,0	7,8	232	0,7	34,0	15,0	5,6	245	0,9	28,5	15,0	3,2	142	0,4	23,0	15,0	1,7	74	0,1	19,0	15,0	1,0	86	0,2	17,5
20,0	7,3	219	0,7	38,0	20,0	5,1	224	0,7	32,5	20,0	2,7	118	0,3	26,5	20,0	1,4	61	0,1	23,5	20,0	0,7	60	0,1	21,5
2nd fan step: V = 850 m³/h																								
-25,0	9,4	281	1,0	8,0	-25,0			*		-25,0					-25,0					-25,0				
-20,0	9,1	270	1,0	12,0	-20,0	7,3	321	1,4	5,5	-20,0				*	-20,0				*	-20,0				
-15,0	8,7	259	0,9	15,5	-15,0	6,9	305	1,3	9,0	-15,0					-15,0			*		-15,0			*	
-10,0	8,3	248	0,8	19,0	-10,0	6,5	288	1,2	13,0	-10,0	4,7	206	0,7	6,5	-10,0					-10,0				
-5,0	8,0	237	0,8	23,0	-5,0	6,1	271	1,0	16,5	-5,0	4,3	189	0,6	10,0	-5,0	3,3	144	0,4	6,5	-5,0				
0,0	7,6	226	0,7	26,5	0,0	5,8	254	0,9	20,0	0,0	3,9	171	0,5	13,5	0,0	2,8	124	0,3	10,0	0,0	2,2	186	0,6	7,5
5,0	7,2	215	0,6	30,0	5,0	5,4	237	0,8	23,5	5,0	3,5	153	0,4	17,0	5,0	2,3	101	0,2	13,0	5,0	1,7	145	0,4	11,0
10,0	6,8	204	0,6	33,5	10,0	5,0	220	0,7	27,5	10,0	3,1	135	0,3	20,5	10,0	1,8	78	0,1	16,0	10,0	1,2	100	0,2	14,0
15,0	6,5	193	0,5	37,5	15,0	4,6	203	0,6	31,0	15,0	2,6	115	0,2	24,0	15,0	1,5	66	0,1	20,0	15,0	0,9	77	0,1	18,0
20,0	6,1	181	0,5	41,0	20,0	4,2	186	0,5	34,5	20,0	2,1	94	0,2	27,5	20,0	1,3	55	0,1	24,5	20,0	0,6	54	0,1	22,0
1st fan step: V = 550 m³/h																								
-25,0	7,4	219	0,7	15,0	-25,0	6,0	263	1,0	7,5	-25,0				*	-25,0					-25,0				
-20,0	7,1	211	0,6	18,5	-20,0	5,7	250	0,9	10,5	-20,0					-20,0			*		-20,0			*	
-15,0	6,8	202	0,6	22,0	-15,0	5,4	238	0,8	14,0	-15,0	4,0	173	0,5	6,5	-15,0					-15,0			*	
-10,0	6,5	194	0,5	25,0	-10,0	5,1	225	0,7	17,5	-10,0	3,7	160	0,4	9,5	-10,0	2,8	123	0,3	5,5	-10,0				
-5,0	6,2	185	0,5	28,5	-5,0	4,8	211	0,7	21,0	-5,0	3,3	146	0,4	13,0	-5,0	2,5	108	0,2	8,5	-5,0	2,0	171	0,5	5,5
0,0	5,9	177	0,4	32,0	0,0	4,5	198	0,6	24,0	0,0	3,0	132	0,3	16,5	0,0	2,0	88	0,2	11,0	0,0	1,6	139	0,4	8,5
5,0	5,6	168	0,4	35,5	5,0	4,2	185	0,5	27,5	5,0	2,7	118	0,3	19,5	5,0	1,7	76	0,1	14,5	5,0	1,2	104	0,2	11,5
10,0	5,3	159	0,4	38,5	10,0	3,9	172	0,5	31,0	10,0	2,3	102	0,2	22,5	10,0	1,5	66	0,1	18,0	10,0	1,0	85	0,2	15,0
15,0	5,1	150	0,3	42,0	15,0	3,6	158	0,4	34,0	15,0	1,9	85	0,1	25,5	15,0	1,3	57	0,1	22,0	15,0	0,8	65	0,1	19,0
20,0	4,8	142	0,3	45,0	20,0	3,3	145	0,3	37,5	20,0	1,5	67	0,1	28,0	20,0	1,1	47	0,1	25,5	20,0	0,5	46	0,1	23,0

*too low temperature at outlet

V – air flow
 PT – heating capacity
 Tp1 – inlet air temperature
 Tp2 – outlet air temperature
 Tw1 – inlet water temperature

Tw2 – outlet water temperature
 Qw – water flow rate in heat exchanger
 Δpw – water pressure drop in heat exchanger



HEATING CAPACITY CALCULATOR

In order to select the device with other parameters scan QR code.

⁽¹⁾ Tp1 - air temperature at the inlet to the water exchanger. This is the result of the outside temperature (Tz), the degree of recirculation and temperature inside the room (Tw).

$Tp1 = (Tz \times V \text{ fresh air} + Tw \times V \text{ recirculated air}) / V$
 i.e. Tz = -20°C, Tw = 16°C, fresh air 70%, Tp1 = -9°C

HEATING CAPACITIES

Tw1 / Tw2 = 120/90°C					Tw1 / Tw2 = 90/70°C					Tw1 / Tw2 = 70/50°C					Tw1 / Tw2 = 60/40°C					Tw1 / Tw2 = 40/30°C				
Tp1	PT	Qw	Δpw	Tp2	Tp1	PT	Qw	Δpw	Tp2	Tp1	PT	Qw	Δpw	Tp2	Tp1	PT	Qw	Δpw	Tp2	Tp1	PT	Qw	Δpw	Tp2
[°C]	[kW]	[l/h]	[kPa]	[°C]	[°C]	[kW]	[l/h]	[kPa]	[°C]	[°C]	[kW]	[l/h]	[kPa]	[°C]	[°C]	[kW]	[l/h]	[kPa]	[°C]	[°C]	[kW]	[l/h]	[kPa]	[°C]
LEO S2 + KM S																								
3rd fan step: V = 1100 m³/h																								
-25,0	22,9	682	8,2	37,0	-25,0	18,5	817	12,2	25,0	-25,0	14,6	637	8,3	14,5	-25,0	12,6	548	6,6	9,0	-25,0				*
-20,0	22,0	656	7,7	39,5	-20,0	17,6	778	11,2	27,5	-20,0	13,7	599	7,4	17,0	-20,0	11,7	509	5,8	11,5	-20,0	9,4	818	14,4	5,5
-15,0	21,2	630	7,1	42,0	-15,0	16,8	739	10,2	30,5	-15,0	12,8	560	6,6	19,5	-15,0	10,8	470	5,0	14,0	-15,0	8,5	740	12,0	8,0
-10,0	20,3	604	6,6	45,0	-10,0	15,9	700	9,2	33,0	-10,0	11,9	521	5,8	22,0	-10,0	9,9	431	4,3	16,5	-10,0	7,6	661	9,8	10,5
-5,0	19,4	578	6,1	47,5	-5,0	15,0	661	8,3	35,5	-5,0	11,0	481	5,0	24,5	-5,0	9,0	391	3,6	19,0	-5,0	6,7	582	7,9	13,0
0,0	18,5	552	5,6	50,0	0,0	14,1	622	7,4	38,0	0,0	10,1	442	4,3	27,0	0,0	8,1	351	3,0	21,5	0,0	5,8	503	6,1	15,5
5,0	17,7	526	5,1	52,5	5,0	13,2	582	6,6	40,5	5,0	9,2	402	3,7	29,5	5,0	7,1	311	2,4	24,0	5,0	4,9	422	4,5	18,0
10,0	16,8	500	4,7	55,0	10,0	12,3	543	5,8	43,0	10,0	8,3	362	3,0	32,0	10,0	6,2	270	1,9	26,5	10,0	3,9	341	3,1	20,5
15,0	15,9	474	4,3	57,5	15,0	11,4	504	5,1	45,5	15,0	7,4	322	2,5	34,5	15,0	5,3	229	1,4	29,0	15,0	3,0	257	1,9	23,0
20,0	15,1	448	3,8	59,5	20,0	10,5	464	4,4	48,0	20,0	6,4	281	1,9	37,0	20,0	4,3	186	1,0	31,5	20,0	1,9	166	0,9	25,0
2nd fan step: V = 800 m³/h																								
-25,0	18,7	557	5,7	44,5	-25,0	15,1	666	8,4	31,0	-25,0	11,9	520	5,8	19,5	-25,0	10,3	447	4,6	13,0	-25,0	8,4	730	11,7	6,5
-20,0	18,0	535	5,3	47,0	-20,0	14,4	635	7,7	33,5	-20,0	11,2	488	5,2	21,5	-20,0	9,5	415	4,0	15,5	-20,0	7,7	666	10,0	8,5
-15,0	17,3	514	4,9	49,0	-15,0	13,7	603	7,0	36,0	-15,0	10,4	457	4,6	24,0	-15,0	8,8	384	3,5	17,5	-15,0	7,0	603	8,4	11,0
-10,0	16,6	493	4,6	51,5	-10,0	12,9	571	6,4	38,0	-10,0	9,7	425	4,0	26,0	-10,0	8,1	351	3,0	20,0	-10,0	6,2	539	6,8	13,0
-5,0	15,8	472	4,2	53,5	-5,0	12,2	539	5,8	40,5	-5,0	9,0	393	3,5	28,5	-5,0	7,3	319	2,5	22,0	-5,0	5,5	474	5,5	15,5
0,0	15,1	450	3,9	56,0	0,0	11,5	507	5,2	42,5	0,0	8,2	360	3,0	30,5	0,0	6,6	287	2,1	24,5	0,0	4,7	410	4,2	17,5
5,0	14,4	429	3,6	58,0	5,0	10,8	475	4,6	44,5	5,0	7,5	328	2,5	32,5	5,0	5,8	254	1,7	26,5	5,0	4,0	344	3,1	19,5
10,0	13,7	408	3,3	60,5	10,0	10,0	443	4,1	47,0	10,0	6,8	295	2,1	35,0	10,0	5,1	220	1,3	28,5	10,0	3,2	277	2,1	22,0
15,0	13,0	387	3,0	62,5	15,0	9,3	411	3,5	49,0	15,0	6,0	263	1,7	37,0	15,0	4,3	186	1,0	30,5	15,0	2,4	208	1,3	24,0
20,0	12,3	366	2,7	64,5	20,0	8,6	379	3,1	51,0	20,0	5,2	229	1,4	39,0	20,0	3,5	150	0,7	32,5	20,0	1,5	128	0,6	25,5
1st fan step: V = 500 m³/h																								
-25,0	13,6	405	3,2	56,0	-25,0	11,0	485	4,8	40,5	-25,0	8,7	378	3,3	26,5	-25,0	7,5	325	2,6	19,5	-25,0	6,1	530	6,7	11,5
-20,0	13,1	390	3,0	58,0	-20,0	10,5	461	4,4	42,5	-20,0	8,1	355	2,9	28,5	-20,0	6,9	302	2,3	21,5	-20,0	5,6	484	5,7	13,5
-15,0	12,6	374	2,8	59,5	-15,0	9,9	438	4,0	44,0	-15,0	7,6	332	2,6	30,0	-15,0	6,4	279	2,0	23,0	-15,0	5,1	438	4,7	15,0
-10,0	12,0	359	2,6	61,5	-10,0	9,4	415	3,6	46,0	-10,0	7,1	309	2,3	32,0	-10,0	5,9	255	1,7	25,0	-10,0	4,5	391	3,9	17,0
-5,0	11,5	343	2,4	63,5	-5,0	8,9	392	3,3	47,5	-5,0	6,5	285	2,0	33,5	-5,0	5,3	232	1,4	26,5	-5,0	4,0	344	3,1	18,5
0,0	11,0	328	2,2	65,0	0,0	8,4	369	2,9	49,5	0,0	6,0	262	1,7	35,5	0,0	4,8	208	1,2	28,5	0,0	3,4	297	2,4	20,5
5,0	10,5	312	2,0	67,0	5,0	7,8	345	2,6	51,0	5,0	5,5	238	1,5	37,0	5,0	4,2	184	1,0	30,0	5,0	2,9	249	1,8	22,0
10,0	10,0	297	1,8	68,5	10,0	7,3	322	2,3	53,0	10,0	4,9	215	1,2	39,0	10,0	3,7	159	0,7	31,5	10,0	2,3	200	1,2	23,5
15,0	9,5	281	1,7	70,5	15,0	6,8	299	2,0	54,5	15,0	4,4	191	1,0	40,5	15,0	3,1	133	0,6	33,0	15,0	1,7	147	0,7	25,0
20,0	8,9	266	1,5	72,0	20,0	6,3	276	1,7	56,5	20,0	3,8	166	0,8	42,0	20,0	2,4	105	0,4	34,0	20,0	1,1	93	0,3	26,5

*too low temperature at outlet

V – air flow
 PT – heating capacity
 Tp1 – inlet air temperature
 Tp2 – outlet air temperature
 Tw1 – inlet water temperature

Tw2 – outlet water temperature
 Qw – water flow rate in heat exchanger
 Δpw – water pressure drop in heat exchanger



HEATING CAPACITY CALCULATOR

In order to select the device with other parameters scan QR code.

⁽¹⁾ Tp1 - air temperature at the inlet to the water exchanger. This is the result of the outside temperature (Tz), the degree of recirculation and temperature inside the room (Tw).

$Tp1 = (Tz \times V \text{ fresh air} + Tw \times V \text{ recirculated air}) / V$
 i.e. Tz = -20°C, Tw = 16°C, fresh air 70%, Tp1 = -9°C

HEATING CAPACITIES

Tw1 / Tw2 = 120/90°C					Tw1 / Tw2 = 90/70°C					Tw1 / Tw2 = 70/50°C					Tw1 / Tw2 = 60/40°C					Tw1 / Tw2 = 40/30°C				
Tp1	PT	Qw	Δpw	Tp2	Tp1	PT	Qw	Δpw	Tp2	Tp1	PT	Qw	Δpw	Tp2	Tp1	PT	Qw	Δpw	Tp2	Tp1	PT	Qw	Δpw	Tp2
[°C]	[kW]	[l/h]	[kPa]	[°C]	[°C]	[kW]	[l/h]	[kPa]	[°C]	[°C]	[kW]	[l/h]	[kPa]	[°C]	[°C]	[kW]	[l/h]	[kPa]	[°C]	[°C]	[kW]	[l/h]	[kPa]	[°C]
LEO S3 + KM S																								
3rd fan step: V = 1000 m³/h																								
-25,0	27,6	821	6,1	57,0	-25,0	22,3	985	9,1	41,5	-25,0	17,5	764	6,1	27,0	-25,0	15,0	653	4,8	19,5	-25,0	12,4	1074	12,5	12,0
-20,0	26,5	789	5,7	59,0	-20,0	21,2	937	8,3	43,0	-20,0	16,4	715	5,5	28,5	-20,0	13,9	605	4,2	21,5	-20,0	11,3	978	10,6	13,5
-15,0	25,4	757	5,3	60,5	-15,0	20,1	888	7,6	45,0	-15,0	15,3	667	4,8	30,5	-15,0	12,8	556	3,6	23,0	-15,0	10,2	882	8,8	15,5
-10,0	24,3	724	4,9	62,5	-10,0	19,0	840	6,8	46,5	-10,0	14,2	619	4,2	32,0	-10,0	11,7	508	3,1	24,5	-10,0	9,1	785	7,1	17,0
-5,0	23,3	692	4,5	64,0	-5,0	17,9	792	6,1	48,0	-5,0	13,0	571	3,6	33,5	-5,0	10,5	459	2,6	26,5	-5,0	7,9	688	5,6	18,5
0,0	22,2	660	4,1	65,5	0,0	16,9	744	5,5	50,0	0,0	11,9	522	3,1	35,5	0,0	9,4	410	2,1	28,0	0,0	6,8	591	4,3	20,0
5,0	21,1	628	3,8	67,0	5,0	15,8	695	4,9	51,5	5,0	10,8	473	2,6	37,0	5,0	8,3	360	1,7	29,5	5,0	5,7	492	3,1	22,0
10,0	20,0	596	3,4	69,0	10,0	14,7	647	4,3	53,0	10,0	9,7	424	2,1	38,5	10,0	7,1	310	1,3	31,0	10,0	4,5	391	2,1	23,5
15,0	19,0	564	3,1	70,5	15,0	13,6	599	3,7	54,5	15,0	8,6	375	1,7	40,0	15,0	5,9	258	0,9	32,5	15,0	3,3	286	1,2	24,5
20,0	17,9	533	2,8	72,0	20,0	12,5	551	3,2	56,0	20,0	7,4	325	1,3	41,5	20,0	4,7	203	0,6	33,5	20,0	1,7	143	0,4	25,0
2nd fan step: V = 700 m³/h																								
-25,0	21,4	636	3,9	66,0	-25,0	17,3	762	5,7	48,5	-25,0	13,5	592	3,9	32,5	-25,0	11,6	506	3,0	24,5	-25,0	9,6	831	7,9	16,0
-20,0	20,5	611	3,6	67,5	-20,0	16,4	725	5,2	50,0	-20,0	12,7	555	3,5	34,0	-20,0	10,8	469	2,7	26,0	-20,0	8,7	757	6,7	17,0
-15,0	19,7	586	3,3	68,5	-15,0	15,6	688	4,8	51,0	-15,0	11,8	517	3,0	35,5	-15,0	9,9	431	2,3	27,0	-15,0	7,9	683	5,5	18,5
-10,0	18,9	561	3,1	70,0	-10,0	14,7	650	4,3	52,5	-10,0	11,0	480	2,7	36,5	-10,0	9,0	394	2,0	28,5	-10,0	7,0	608	4,5	20,0
-5,0	18,0	536	2,8	71,5	-5,0	13,9	613	3,9	54,0	-5,0	10,1	442	2,3	38,0	-5,0	8,2	356	1,6	29,5	-5,0	6,2	533	3,6	21,0
0,0	17,2	511	2,6	72,5	0,0	13,1	576	3,5	55,0	0,0	9,3	405	2,0	39,0	0,0	7,3	317	1,3	31,0	0,0	5,3	457	2,7	22,5
5,0	16,3	487	2,4	74,0	5,0	12,2	538	3,1	56,5	5,0	8,4	367	1,7	40,5	5,0	6,4	279	1,1	32,0	5,0	4,4	380	2,0	23,5
10,0	15,5	462	2,2	75,0	10,0	11,4	501	2,7	57,5	10,0	7,5	329	1,4	41,5	10,0	5,5	239	0,8	33,0	10,0	3,5	301	1,3	24,5
15,0	14,7	437	2,0	76,5	15,0	10,5	464	2,3	59,0	15,0	6,6	291	1,1	43,0	15,0	4,5	198	0,6	34,0	15,0	2,5	216	0,7	25,5
20,0	13,9	413	1,8	77,5	20,0	9,7	427	2,0	60,0	20,0	5,8	252	0,8	44,0	20,0	3,5	151	0,4	34,5	20,0	1,4	124	0,3	26,0
1st fan step: V = 450 m³/h																								
-25,0	15,3	454	2,1	76,0	-25,0	12,3	544	3,1	56,5	-25,0	9,7	423	2,1	39,0	-25,0	8,3	362	1,7	30,0	-25,0	6,8	593	4,3	20,5
-20,0	14,7	436	2,0	77,0	-20,0	11,7	517	2,9	57,5	-20,0	9,1	396	1,9	40,0	-20,0	7,7	335	1,5	31,0	-20,0	6,2	540	3,7	21,5
-15,0	14,1	419	1,8	78,0	-15,0	11,1	491	2,6	58,5	-15,0	8,5	370	1,7	41,0	-15,0	7,1	308	1,3	32,0	-15,0	5,6	487	3,0	22,0
-10,0	13,5	401	1,7	79,0	-10,0	10,5	464	2,3	59,5	-10,0	7,8	343	1,5	42,0	-10,0	6,5	281	1,1	32,5	-10,0	5,0	434	2,5	23,0
-5,0	12,9	383	1,5	79,5	-5,0	9,9	437	2,1	60,5	-5,0	7,2	316	1,3	42,5	-5,0	5,8	254	0,9	33,5	-5,0	4,4	380	2,0	24,0
0,0	12,3	365	1,4	80,5	0,0	9,3	411	1,9	61,0	0,0	6,6	289	1,1	43,5	0,0	5,2	226	0,7	34,0	0,0	3,8	326	1,5	24,5
5,0	11,7	348	1,3	81,5	5,0	8,7	384	1,7	62,0	5,0	6,0	262	0,9	44,5	5,0	4,5	198	0,6	34,5	5,0	3,1	270	1,1	25,5
10,0	11,1	330	1,2	82,5	10,0	8,1	358	1,5	63,0	10,0	5,4	235	0,8	45,0	10,0	3,9	168	0,4	35,0	10,0	2,4	211	0,7	26,0
15,0	10,5	313	1,1	83,0	15,0	7,5	332	1,3	64,0	15,0	4,7	207	0,6	46,0	15,0	3,1	135	0,3	35,0	15,0	1,6	141	0,3	25,5
20,0	9,9	296	1,0	84,0	20,0	6,9	305	1,1	64,5	20,0	4,1	179	0,5	46,5	20,0	2,3	102	0,2	35,0	20,0	1,2	100	0,2	27,5

V – air flow
 PT – heating capacity
 Tp1 – inlet air temperature
 Tp2 – outlet air temperature
 Tw1 – inlet water temperature

Tw2 – outlet water temperature
 Qw – water flow rate in heat exchanger
 Δpw – water pressure drop in heat exchanger



HEATING CAPACITY CALCULATOR

In order to select the device with other parameters scan QR code.

⁽¹⁾ Tp1 - air temperature at the inlet to the water exchanger. This is the result of the outside temperature (Tz), the degree of recirculation and temperature inside the room (Tw).

$$Tp1 = (Tz \times V \text{ fresh air} + Tw \times V \text{ recirculated air}) / V$$
 i.e. Tz = -20°C, Tw = 16°C, fresh air 70%, Tp1 = -9°C

HEATING CAPACITIES

Tw1 / Tw2 = 120/90°C					Tw1 / Tw2 = 90/70°C					Tw1 / Tw2 = 70/50°C					Tw1 / Tw2 = 60/40°C					Tw1 / Tw2 = 40/30°C				
Tp1	PT	Qw	Δpw	Tp2	Tp1	PT	Qw	Δpw	Tp2	Tp1	PT	Qw	Δpw	Tp2	Tp1	PT	Qw	Δpw	Tp2	Tp1	PT	Qw	Δpw	Tp2
[°C]	[kW]	[l/h]	[kPa]	[°C]	[°C]	[kW]	[l/h]	[kPa]	[°C]	[°C]	[kW]	[l/h]	[kPa]	[°C]	[°C]	[kW]	[l/h]	[kPa]	[°C]	[°C]	[kW]	[l/h]	[kPa]	[°C]
LEO L1 + KM L																								
3rd fan step: V = 2600 m³/h																								
-25,0	31,0	923	6,6	10,5	-25,0	*				-25,0					-25,0					-25,0				
-20,0	29,8	887	6,1	14,0	-20,0	24,0	1057	8,9	7,5	-20,0		*			-20,0					-20,0		*		
-15,0	28,6	851	5,7	17,5	-15,0	22,7	1003	8,1	11,0	-15,0					-15,0		*			-15,0		*		
-10,0	27,4	815	5,2	21,5	-10,0	21,5	948	7,3	14,5	-10,0	15,8	689	4,4	8,0	-10,0					-10,0				
-5,0	26,2	779	4,8	25,0	-5,0	20,2	893	6,6	18,0	-5,0	14,5	634	3,8	11,5	-5,0	11,5	502	2,6	8,0	-5,0	8,8	764	5,8	5,0
0,0	24,9	743	4,4	28,5	0,0	19,0	838	5,9	21,5	0,0	13,2	578	3,2	15,0	0,0	10,2	446	2,1	11,5	0,0	7,5	651	4,4	8,5
5,0	23,7	706	4,0	32,0	5,0	17,7	783	5,2	25,0	5,0	11,9	522	2,7	18,5	5,0	8,9	389	1,6	15,0	5,0	6,2	537	3,1	12,0
10,0	22,5	669	3,6	35,5	10,0	16,5	727	4,5	28,5	10,0	10,6	466	2,2	22,0	10,0	7,6	330	1,2	18,5	10,0	4,8	420	2,0	15,5
15,0	21,3	633	3,3	39,0	15,0	15,2	672	3,9	32,0	15,0	9,3	408	1,7	25,5	15,0	6,2	270	0,9	22,0	15,0	3,4	296	1,1	19,0
20,0	20,0	596	3,0	42,5	20,0	14,0	616	3,3	35,5	20,0	8,0	350	1,3	29,0	20,0	4,7	205	0,5	25,0	20,0	1,4	124	0,2	21,5
2nd fan step: V = 1600 m³/h																								
-25,0	23,6	703	4,0	19,0	-25,0	19,2	845	5,9	10,5	-25,0		*			-25,0					-25,0				
-20,0	22,7	676	3,7	22,5	-20,0	18,2	804	5,4	14,0	-20,0	13,9	608	3,5	6,0	-20,0		*			-20,0			*	
-15,0	21,8	649	3,4	25,5	-15,0	17,3	763	4,9	17,0	-15,0	12,9	566	3,1	9,0	-15,0					-15,0				*
-10,0	20,9	621	3,2	29,0	-10,0	16,4	722	4,5	20,5	-10,0	12,0	525	2,7	12,5	-10,0	9,7	424	1,9	8,0	-10,0				
-5,0	20,0	594	2,9	32,0	-5,0	15,4	680	4,0	23,5	-5,0	11,0	483	2,3	15,5	-5,0	8,8	382	1,6	11,5	-5,0	6,7	580	3,5	7,5
0,0	19,0	566	2,7	35,0	0,0	14,5	638	3,6	27,0	0,0	10,1	440	2,0	18,5	0,0	7,8	339	1,3	14,5	0,0	5,7	494	2,7	10,5
5,0	18,1	539	2,5	38,5	5,0	13,5	596	3,2	30,0	5,0	9,1	398	1,6	22,0	5,0	6,8	294	1,0	17,5	5,0	4,7	406	1,9	13,5
10,0	17,2	511	2,2	41,5	10,0	12,6	554	2,8	33,0	10,0	8,1	354	1,3	25,0	10,0	5,7	249	0,7	20,5	10,0	3,6	316	1,2	16,5
15,0	16,2	483	2,0	44,5	15,0	11,6	512	2,4	36,0	15,0	7,1	311	1,0	28,0	15,0	4,6	201	0,5	23,5	15,0	2,5	215	0,6	19,5
20,0	15,3	456	1,8	48,0	20,0	10,6	470	2,1	39,5	20,0	6,1	266	0,8	31,0	20,0	3,3	143	0,3	26,0	20,0	1,3	109	0,2	22,5
1st fan step: V = 800 m³/h																								
-25,0	15,6	463	1,9	33,0	-25,0	12,6	556	2,8	22,0	-25,0	9,8	426	1,8	11,5	-25,0	8,3	361	1,4	6,0	-25,0			*	
-20,0	15,0	445	1,7	35,5	-20,0	12,0	529	2,5	24,5	-20,0	9,1	399	1,6	14,0	-20,0	7,7	333	1,2	8,5	-20,0				*
-15,0	14,4	427	1,6	38,5	-15,0	11,4	501	2,3	27,5	-15,0	8,5	372	1,4	16,5	-15,0	7,0	305	1,1	11,0	-15,0	5,7	490	2,6	6,0
-10,0	13,8	409	1,5	41,0	-10,0	10,8	474	2,1	30,0	-10,0	7,9	344	1,3	19,5	-10,0	6,4	277	0,9	13,5	-10,0	5,0	435	2,1	8,5
-5,0	13,1	391	1,4	43,5	-5,0	10,1	447	1,9	32,5	-5,0	7,2	317	1,1	22,0	-5,0	5,7	249	0,7	16,0	-5,0	4,4	378	1,7	11,0
0,0	12,5	373	1,3	46,5	0,0	9,5	420	1,7	35,0	0,0	6,6	289	0,9	24,5	0,0	5,0	219	0,6	18,5	0,0	3,7	321	1,2	13,5
5,0	11,9	355	1,2	49,0	5,0	8,9	392	1,5	38,0	5,0	6,0	260	0,8	27,0	5,0	4,3	189	0,5	21,0	5,0	3,0	261	0,9	16,0
10,0	11,3	337	1,1	51,5	10,0	8,3	364	1,3	40,5	10,0	5,3	232	0,6	29,5	10,0	3,6	156	0,3	23,0	10,0	2,3	196	0,5	18,5
15,0	10,7	318	1,0	54,0	15,0	7,6	337	1,1	43,0	15,0	4,6	202	0,5	32,0	15,0	2,4	106	0,2	24,0	15,0	1,4	123	0,2	20,0
20,0	10,1	300	0,9	56,5	20,0	7,0	309	1,0	45,5	20,0	3,9	172	0,4	34,5	20,0	2,0	88	0,1	27,5	20,0	1,0	87	0,1	23,5

*too low temperature at outlet

V – air flow
 PT – heating capacity
 Tp1 – inlet air temperature
 Tp2 – outlet air temperature
 Tw1 – inlet water temperature

Tw2 – outlet water temperature
 Qw – water flow rate in heat exchanger
 Δpw – water pressure drop in heat exchanger



HEATING CAPACITY CALCULATOR

In order to select the device with other parameters scan QR code.

⁽¹⁾ Tp1 - air temperature at the inlet to the water exchanger. This is the result of the outside temperature (Tz), the degree of recirculation and temperature inside the room (Tw).

$Tp1 = (Tz \times V \text{ fresh air} + Tw \times V \text{ recirculated air}) / V$
 i.e. Tz = -20°C, Tw = 16°C, fresh air 70%, Tp1 = -9°C

HEATING CAPACITIES

Tw1 / Tw2 = 120/90°C					Tw1 / Tw2 = 90/70°C					Tw1 / Tw2 = 70/50°C					Tw1 / Tw2 = 60/40°C					Tw1 / Tw2 = 40/30°C				
Tp1	PT	Qw	Δpw	Tp2	Tp1	PT	Qw	Δpw	Tp2	Tp1	PT	Qw	Δpw	Tp2	Tp1	PT	Qw	Δpw	Tp2	Tp1	PT	Qw	Δpw	Tp2
[°C]	[kW]	[l/h]	[kPa]	[°C]	[°C]	[kW]	[l/h]	[kPa]	[°C]	[°C]	[kW]	[l/h]	[kPa]	[°C]	[°C]	[kW]	[l/h]	[kPa]	[°C]	[°C]	[kW]	[l/h]	[kPa]	[°C]
LEO L2 + KM L																								
3rd fan step: V = 2400 m³/h																								
-25,0	47,2	1405	7,0	40,0	-25,0	38,2	1686	10,4	27,5	-25,0	29,9	1308	7,0	16,0	-25,0	25,7	1119	5,5	10,5	-25,0	*			
-20,0	45,4	1351	6,5	42,5	-20,0	36,4	1604	9,5	30,0	-20,0	28,0	1226	6,2	18,5	-20,0	23,8	1038	4,8	13,0	-20,0	19,4	1677	12,0	6,5
-15,0	43,5	1296	6,0	45,0	-15,0	34,5	1522	8,6	32,5	-15,0	26,2	1145	5,5	21,0	-15,0	21,9	956	4,1	15,0	-15,0	17,5	1514	10,0	9,0
-10,0	41,7	1242	5,6	47,5	-10,0	32,6	1440	7,8	35,0	-10,0	24,3	1063	4,8	23,5	-10,0	20,0	873	3,5	17,5	-10,0	15,6	1349	8,1	11,5
-5,0	39,9	1187	5,1	50,0	-5,0	30,8	1358	7,0	37,5	-5,0	22,4	980	4,2	26,0	-5,0	18,1	790	2,9	20,0	-5,0	13,7	1184	6,5	14,0
0,0	38,0	1132	4,7	52,0	0,0	28,9	1276	6,3	39,5	0,0	20,5	898	3,6	28,0	0,0	16,2	707	2,4	22,0	0,0	11,7	1018	4,9	16,0
5,0	36,2	1078	4,3	54,5	5,0	27,1	1194	5,6	42,0	5,0	18,6	815	3,0	30,5	5,0	14,3	622	1,9	24,5	5,0	9,8	850	3,6	18,5
10,0	34,4	1023	3,9	57,0	10,0	25,2	1112	4,9	44,5	10,0	16,7	731	2,5	33,0	10,0	12,3	537	1,5	27,0	10,0	7,8	679	2,4	20,5
15,0	32,6	969	3,6	59,0	15,0	23,3	1029	4,3	46,5	15,0	14,8	647	2,0	35,0	15,0	10,3	450	1,1	29,0	15,0	5,8	502	1,4	23,0
20,0	30,7	915	3,2	61,5	20,0	21,5	947	3,7	49,0	20,0	12,8	562	1,5	37,5	20,0	8,2	359	0,7	31,0	20,0	3,5	302	0,6	24,5
2nd fan step: V = 1500 m³/h																								
-25,0	34,7	1032	4,0	51,5	-25,0	28,0	1236	5,9	37,0	-25,0	21,9	960	4,0	23,5	-25,0	18,8	821	3,1	16,5	-25,0	15,6	1348	8,1	9,5
-20,0	33,3	991	3,7	53,5	-20,0	26,6	1176	5,4	39,0	-20,0	20,6	900	3,6	25,5	-20,0	17,5	761	2,8	18,5	-20,0	14,2	1229	6,9	11,5
-15,0	32,0	951	3,4	55,5	-15,0	25,3	1116	4,9	40,5	-15,0	19,2	840	3,2	27,5	-15,0	16,1	701	2,4	20,5	-15,0	12,8	1109	5,7	13,0
-10,0	30,6	911	3,2	57,5	-10,0	23,9	1056	4,5	42,5	-10,0	17,8	780	2,8	29,0	-10,0	14,7	641	2,0	22,5	-10,0	11,4	988	4,7	15,0
-5,0	29,3	871	2,9	59,5	-5,0	22,6	996	4,0	44,5	-5,0	16,4	719	2,4	31,0	-5,0	13,3	580	1,7	24,0	-5,0	10,0	867	3,7	17,0
0,0	27,9	831	2,7	61,0	0,0	21,2	936	3,6	46,5	0,0	15,1	659	2,0	33,0	0,0	11,9	518	1,4	26,0	0,0	8,6	745	2,8	19,0
5,0	26,6	791	2,5	63,0	5,0	19,8	876	3,2	48,5	5,0	13,7	598	1,7	35,0	5,0	10,5	456	1,1	28,0	5,0	7,2	621	2,1	20,5
10,0	25,2	751	2,2	65,0	10,0	18,5	815	2,8	50,0	10,0	12,3	537	1,4	36,5	10,0	9,0	392	0,9	29,5	10,0	5,7	495	1,4	22,5
15,0	23,9	712	2,0	67,0	15,0	17,1	755	2,4	52,0	15,0	10,9	475	1,1	38,5	15,0	7,5	327	0,6	31,0	15,0	4,2	361	0,8	24,0
20,0	22,6	672	1,8	68,5	20,0	15,8	695	2,1	54,0	20,0	9,4	412	0,9	40,5	20,0	5,9	256	0,4	32,5	20,0	2,2	192	0,3	25,0
1st fan step: V = 700 m³/h																								
-25,0	20,0	595	1,5	69,5	-25,0	16,1	712	2,2	51,5	-25,0	12,7	554	1,5	35,0	-25,0	10,9	474	1,2	26,5	-25,0	9,0	776	3,0	17,5
-20,0	19,2	572	1,4	71,0	-20,0	15,4	677	2,0	52,5	-20,0	11,9	519	1,3	36,0	-20,0	10,1	439	1,0	27,5	-20,0	8,2	707	2,6	18,5
-15,0	18,4	549	1,3	72,0	-15,0	14,6	643	1,8	54,0	-15,0	11,1	484	1,2	37,5	-15,0	9,3	404	0,9	29,0	-15,0	7,4	638	2,2	20,0
-10,0	17,7	526	1,2	73,0	-10,0	13,8	608	1,7	55,0	-10,0	10,3	450	1,0	38,5	-10,0	8,5	368	0,8	30,0	-10,0	6,6	568	1,8	21,0
-5,0	16,9	502	1,1	74,5	-5,0	13,0	574	1,5	56,0	-5,0	9,5	415	0,9	39,5	-5,0	7,6	332	0,6	31,0	-5,0	5,7	498	1,4	22,0
0,0	16,1	479	1,0	75,5	0,0	12,2	539	1,3	57,5	0,0	8,7	380	0,8	41,0	0,0	6,8	296	0,5	32,0	0,0	4,9	426	1,1	23,0
5,0	15,3	456	0,9	77,0	5,0	11,4	505	1,2	58,5	5,0	7,9	344	0,6	42,0	5,0	5,9	258	0,4	33,0	5,0	4,1	353	0,8	24,0
10,0	14,6	434	0,8	78,0	10,0	10,7	470	1,0	59,5	10,0	7,1	308	0,5	43,0	10,0	5,0	218	0,3	33,5	10,0	3,2	273	0,5	24,5
15,0	13,8	411	0,8	79,0	15,0	9,9	436	0,9	61,0	15,0	6,2	272	0,4	44,0	15,0	3,9	171	0,2	33,0	15,0	2,2	189	0,3	25,0
20,0	13,1	388	0,7	80,0	20,0	9,1	401	0,8	62,0	20,0	5,4	235	0,3	44,5	20,0	3,2	137	0,1	34,5	20,0	1,6	135	0,1	27,0

*too low temperature at outlet

V – air flow
 PT – heating capacity
 Tp1 – inlet air temperature
 Tp2 – outlet air temperature
 Tw1 – inlet water temperature

Tw2 – outlet water temperature
 Qw – water flow rate in heat exchanger
 Δpw – water pressure drop in heat exchanger



HEATING CAPACITY CALCULATOR

In order to select the device with other parameters scan QR code.

⁽¹⁾ Tp1 - air temperature at the inlet to the water exchanger. This is the result of the outside temperature (Tz), the degree of recirculation and temperature inside the room (Tw).

$Tp1 = (Tz \times V \text{ fresh air} + Tw \times V \text{ recirculated air}) / V$
 i.e. Tz = -20°C, Tw = 16°C, fresh air 70%, Tp1 = -9°C

HEATING CAPACITIES

Tw1 / Tw2 = 120/90°C					Tw1 / Tw2 = 90/70°C					Tw1 / Tw2 = 70/50°C					Tw1 / Tw2 = 60/40°C					Tw1 / Tw2 = 40/30 °C				
Tp1	PT	Qw	Δpw	Tp2	Tp1	PT	Qw	Δpw	Tp2	Tp1	PT	Qw	Δpw	Tp2	Tp1	PT	Qw	Δpw	Tp2	Tp1	PT	Qw	Δpw	Tp2
[°C]	[kW]	[l/h]	[kPa]	[°C]	[°C]	[kW]	[l/h]	[kPa]	[°C]	[°C]	[kW]	[l/h]	[kPa]	[°C]	[°C]	[kW]	[l/h]	[kPa]	[°C]	[°C]	[kW]	[l/h]	[kPa]	[°C]
LEO L3 + KM L																								
3rd fan step: V = 2250 m³/h																								
-25,0	60,9	1813	10,5	64,5	-25,0	48,9	2160	15,4	47,0	-25,0	38,8	1697	10,6	32,0	-25,0	33,6	1466	8,4	24,5	-25,0	27,2	2362	21,1	15,0
-20,0	58,6	1744	9,8	66,0	-20,0	46,6	2058	14,1	48,5	-20,0	36,5	1595	9,5	33,5	-20,0	31,3	1365	7,4	26,0	-20,0	24,9	2160	18,0	16,5
-15,0	56,3	1676	9,1	67,5	-15,0	44,3	1956	12,9	50,0	-15,0	34,1	1494	8,4	35,0	-15,0	29,0	1263	6,5	27,5	-15,0	22,6	1957	15,1	18,0
-10,0	54,0	1608	8,4	69,0	-10,0	42,0	1854	11,7	51,5	-10,0	31,8	1392	7,4	36,5	-10,0	26,6	1160	5,5	29,0	-10,0	20,2	1754	12,4	19,5
-5,0	51,7	1539	7,8	70,5	-5,0	39,7	1752	10,5	53,0	-5,0	29,5	1289	6,5	38,0	-5,0	24,3	1057	4,7	30,5	-5,0	17,9	1550	9,9	21,0
0,0	49,4	1472	7,2	72,0	0,0	37,4	1651	9,4	54,5	0,0	27,1	1187	5,6	39,5	0,0	21,9	953	3,9	32,0	0,0	15,5	1344	7,7	22,5
5,0	47,2	1404	6,6	73,5	5,0	35,1	1549	8,4	56,0	5,0	24,8	1084	4,7	41,0	5,0	19,5	849	3,2	33,5	5,0	13,1	1137	5,7	24,0
10,0	44,9	1336	6,0	75,0	10,0	32,8	1447	7,4	57,5	10,0	22,4	980	3,9	42,5	10,0	17,0	743	2,5	34,5	10,0	10,7	926	4,0	25,5
15,0	42,6	1269	5,5	76,5	15,0	30,5	1345	6,5	59,0	15,0	20,0	876	3,2	44,0	15,0	14,6	635	1,9	36,0	15,0	8,2	710	2,5	27,0
20,0	40,4	1203	5,0	78,0	20,0	28,2	1244	5,7	60,5	20,0	17,6	770	2,6	45,0	20,0	12,0	523	1,4	37,0	20,0	5,5	479	1,3	28,0
2nd fan step: V = 1350 m³/h																								
-25,0	42,0	1250	5,3	78,0	-25,0	33,7	1486	7,8	57,5	-25,0	26,8	1171	5,4	40,5	-25,0	23,3	1014	4,4	32,0	-25,0	18,7	1624	10,8	21,0
-20,0	40,4	1203	5,0	79,0	-20,0	32,1	1416	7,2	58,5	-20,0	25,2	1102	4,9	41,5	-20,0	21,7	944	3,8	33,0	-20,0	17,2	1486	9,2	22,0
-15,0	38,8	1156	4,6	80,0	-15,0	30,5	1347	6,5	59,5	-15,0	23,6	1032	4,3	43,0	-15,0	20,1	874	3,4	34,0	-15,0	15,6	1348	7,7	23,0
-10,0	37,3	1110	4,3	81,0	-10,0	28,9	1277	5,9	61,0	-10,0	22,0	962	3,8	44,0	-10,0	18,4	804	2,9	35,0	-10,0	14,0	1209	6,4	24,0
-5,0	35,7	1063	4,0	82,0	-5,0	27,4	1208	5,4	62,0	-5,0	20,4	892	3,3	45,0	-5,0	16,8	733	2,5	36,0	-5,0	12,3	1069	5,1	25,0
0,0	34,2	1017	3,7	83,0	0,0	25,8	1138	4,8	63,0	0,0	18,8	822	2,9	46,0	0,0	15,2	662	2,0	37,0	0,0	10,7	928	4,0	26,0
5,0	32,6	970	3,4	84,0	5,0	24,2	1069	4,3	64,0	5,0	17,2	751	2,5	46,5	5,0	13,5	589	1,7	38,0	5,0	9,1	786	3,0	27,0
10,0	31,1	924	3,1	85,0	10,0	22,7	999	3,8	65,0	10,0	15,6	680	2,1	47,5	10,0	11,8	516	1,3	38,5	10,0	7,4	641	2,1	28,0
15,0	29,5	879	2,8	86,0	15,0	21,1	930	3,4	65,5	15,0	13,9	609	1,7	48,5	15,0	10,1	441	1,0	39,5	15,0	5,6	489	1,3	28,5
20,0	28,0	834	2,6	87,0	20,0	19,5	861	2,9	66,5	20,0	12,3	536	1,4	49,5	20,0	8,3	362	0,7	40,0	20,0	3,7	316	0,6	28,5
1st fan step: V = 600 m³/h																								
-25,0	21,9	653	1,7	95,5	-25,0	17,5	773	2,4	71,5	-25,0	14,0	613	1,7	52,5	-25,0	12,2	532	1,4	42,5	-25,0	9,8	846	3,4	29,0
-20,0	21,1	628	1,5	96,0	-20,0	16,7	738	2,2	72,0	-20,0	13,2	577	1,5	52,5	-20,0	11,4	496	1,2	42,5	-20,0	8,9	774	2,9	29,5
-15,0	20,3	604	1,4	96,5	-15,0	15,9	702	2,0	72,5	-15,0	12,4	541	1,4	53,0	-15,0	10,5	459	1,1	43,0	-15,0	8,1	703	2,4	29,5
-10,0	19,5	580	1,3	97,0	-10,0	15,1	666	1,9	73,0	-10,0	11,5	505	1,2	53,5	-10,0	9,7	422	0,9	43,5	-10,0	7,3	631	2,0	30,0
-5,0	18,7	556	1,2	97,5	-5,0	14,3	630	1,7	73,5	-5,0	10,7	469	1,1	54,0	-5,0	8,8	385	0,8	43,5	-5,0	6,4	559	1,6	30,5
0,0	17,9	532	1,2	98,0	0,0	13,5	595	1,5	74,0	0,0	9,9	432	0,9	54,0	0,0	8,0	348	0,7	43,5	0,0	5,6	485	1,3	30,5
5,0	17,1	509	1,1	98,5	5,0	12,7	559	1,4	74,0	5,0	9,0	396	0,8	54,5	5,0	7,1	309	0,5	44,0	5,0	4,7	410	1,0	31,0
10,0	16,3	485	1,0	98,5	10,0	11,9	524	1,2	74,5	10,0	8,2	359	0,7	54,5	10,0	6,2	269	0,4	43,5	10,0	3,8	330	0,7	31,0
15,0	15,5	462	0,9	99,0	15,0	11,1	488	1,1	75,0	15,0	7,3	321	0,6	55,0	15,0	5,2	225	0,3	43,0	15,0	2,8	238	0,4	30,0
20,0	14,8	439	0,8	99,0	20,0	10,3	453	0,9	75,0	20,0	6,5	283	0,4	54,5	20,0	4,1	177	0,2	42,0	20,0	2,0	175	0,2	31,0

V – air flow
 PT – heating capacity
 Tp1 – inlet air temperature
 Tp2 – outlet air temperature
 Tw1 – inlet water temperature

Tw2 – outlet water temperature
 Qw – water flow rate in heat exchanger
 Δpw – water pressure drop in heat exchanger



HEATING CAPACITY CALCULATOR

In order to select the device with other parameters scan QR code.

⁽¹⁾ Tp1 - air temperature at the inlet to the water exchanger. This is the result of the outside temperature (Tz), the degree of recirculation and temperature inside the room (Tw).

$Tp1 = (Tz \times V \text{ fresh air} + Tw \times V \text{ recirculated air}) / V$
 i.e. Tz = -20°C, Tw = 16°C, fresh air 70%, Tp1 = -9°C

HEATING CAPACITIES

Tw1 / Tw2 = 120/90°C					Tw1 / Tw2 = 90/70°C					Tw1 / Tw2 = 70/50°C					Tw1 / Tw2 = 60/40°C					Tw1 / Tw2 = 40/30°C				
Tp1	PT	Qw	Δpw	Tp2	Tp1	PT	Qw	Δpw	Tp2	Tp1	PT	Qw	Δpw	Tp2	Tp1	PT	Qw	Δpw	Tp2	Tp1	PT	Qw	Δpw	Tp2
[°C]	[kW]	[l/h]	[kPa]	[°C]	[°C]	[kW]	[l/h]	[kPa]	[°C]	[°C]	[kW]	[l/h]	[kPa]	[°C]	[°C]	[kW]	[l/h]	[kPa]	[°C]	[°C]	[kW]	[l/h]	[kPa]	[°C]
LEO XL2 + KM XL																								
3rd fan step: V = 3700 m³/h																								
-25,0	87,1	2592	20,1	51,5	-25,0	70,4	3106	29,7	37,0	-25,0	55,5	2428	20,1	23,5	-25,0	48,0	2091	15,9	17,0	-25,0	39,3	3411	40,8	9,5
-20,0	83,7	2492	18,7	53,5	-20,0	67,0	2957	27,2	39,0	-20,0	52,1	2279	17,9	25,5	-20,0	44,6	1943	13,9	19,0	-20,0	35,9	3115	34,6	11,5
-15,0	80,3	2392	17,3	55,5	-15,0	63,6	2807	24,7	41,0	-15,0	48,7	2130	15,9	27,5	-15,0	41,2	1794	12,1	21,0	-15,0	32,5	2818	28,9	13,5
-10,0	77,0	2292	16,0	57,5	-10,0	60,2	2658	22,4	43,0	-10,0	45,3	1981	13,9	29,5	-10,0	37,7	1644	10,3	23,0	-10,0	29,1	2519	23,6	15,5
-5,0	73,6	2192	14,8	59,5	-5,0	56,8	2508	20,1	44,5	-5,0	41,9	1831	12,1	31,5	-5,0	34,3	1494	8,7	25,0	-5,0	25,6	2220	18,8	17,5
0,0	70,3	2093	13,6	61,5	0,0	53,5	2359	18,0	46,5	0,0	38,4	1682	10,4	33,5	0,0	30,8	1344	7,2	27,0	0,0	22,1	1919	14,5	19,5
5,0	66,9	1993	12,4	63,0	5,0	50,1	2209	16,0	48,5	5,0	35,0	1531	8,7	35,5	5,0	27,4	1192	5,8	29,0	5,0	18,7	1616	10,6	21,0
10,0	63,6	1894	11,3	65,0	10,0	46,7	2060	14,1	50,5	10,0	31,5	1380	7,3	37,5	10,0	23,8	1039	4,5	30,5	10,0	15,1	1311	7,3	23,0
15,0	60,3	1795	10,3	67,0	15,0	43,3	1911	12,3	52,5	15,0	28,1	1228	5,9	39,0	15,0	20,3	884	3,4	32,5	15,0	11,5	1001	4,5	25,0
20,0	57,0	1698	9,3	69,0	20,0	39,9	1762	10,6	54,0	20,0	24,6	1075	4,6	41,0	20,0	16,7	727	2,4	34,5	20,0	7,8	680	2,3	26,5
2nd fan step: V = 2700 m³/h																								
-25,0	70,1	2086	13,5	59,5	-25,0	56,6	2498	20,0	43,0	-25,0	44,7	1954	13,6	29,0	-25,0	38,6	1684	10,8	21,5	-25,0	31,6	2743	27,5	13,0
-20,0	67,4	2005	12,5	61,0	-20,0	53,9	2378	18,3	45,0	-20,0	41,9	1835	12,1	30,5	-20,0	35,9	1565	9,4	23,0	-20,0	28,9	2505	23,4	15,0
-15,0	64,7	1925	11,6	62,5	-15,0	51,2	2258	16,6	46,5	-15,0	39,2	1715	10,7	32,0	-15,0	33,2	1445	8,2	25,0	-15,0	26,1	2266	19,5	16,5
-10,0	61,9	1844	10,8	64,5	-10,0	48,4	2138	15,0	48,0	-10,0	36,5	1595	9,4	34,0	-10,0	30,4	1325	7,0	26,5	-10,0	23,4	2027	16,0	18,0
-5,0	59,3	1764	9,9	66,0	-5,0	45,7	2017	13,5	50,0	-5,0	33,7	1475	8,2	35,5	-5,0	27,6	1204	5,9	28,0	-5,0	20,6	1786	12,7	19,5
0,0	56,6	1684	9,1	67,5	0,0	43,0	1898	12,1	51,5	0,0	31,0	1354	7,0	37,0	0,0	24,9	1083	4,9	29,5	0,0	17,8	1545	9,8	21,5
5,0	53,9	1604	8,3	69,0	5,0	40,3	1777	10,7	53,0	5,0	28,2	1233	5,9	38,5	5,0	22,1	961	3,9	31,5	5,0	15,0	1302	7,2	23,0
10,0	51,2	1524	7,6	71,0	10,0	37,6	1658	9,5	54,5	10,0	25,4	1112	4,9	40,0	10,0	19,2	838	3,1	33,0	10,0	12,2	1056	5,0	24,5
15,0	48,6	1446	6,9	72,5	15,0	34,9	1538	8,3	56,0	15,0	22,6	990	4,0	41,5	15,0	16,4	713	2,3	34,5	15,0	9,3	806	3,1	26,0
20,0	45,9	1367	6,2	74,0	20,0	32,1	1418	7,1	57,5	20,0	19,8	867	3,2	43,5	20,0	13,4	586	1,6	36,0	20,0	6,3	544	1,6	27,5
1st fan step: V = 1600 m³/h																								
-25,0	47,7	1419	6,7	71,5	-25,0	38,5	1698	9,9	53,0	-25,0	30,4	1331	6,8	37,0	-25,0	26,4	1148	5,4	28,5	-25,0	21,5	1866	13,8	18,5
-20,0	45,8	1364	6,2	73,0	-20,0	36,6	1617	9,1	54,5	-20,0	28,6	1250	6,1	38,0	-20,0	24,5	1067	4,8	29,5	-20,0	19,7	1704	11,7	20,0
-15,0	44,0	1309	5,8	74,0	-15,0	34,8	1535	8,2	55,5	-15,0	26,7	1168	5,4	39,0	-15,0	22,6	985	4,1	31,0	-15,0	17,8	1542	9,8	21,0
-10,0	42,1	1255	5,3	75,5	-10,0	32,9	1453	7,5	56,5	-10,0	24,8	1087	4,7	40,5	-10,0	20,7	904	3,5	32,0	-10,0	15,9	1379	8,0	22,5
-5,0	40,3	1200	4,9	76,5	-5,0	31,1	1372	6,7	58,0	-5,0	23,0	1005	4,1	41,5	-5,0	18,9	821	3,0	33,0	-5,0	14,0	1216	6,4	23,5
0,0	38,5	1146	4,5	77,5	0,0	29,2	1290	6,0	59,0	0,0	21,1	923	3,5	42,5	0,0	17,0	739	2,5	34,0	0,0	12,1	1052	5,0	24,5
5,0	36,7	1091	4,2	78,5	5,0	27,4	1209	5,4	60,0	5,0	19,2	841	3,0	43,5	5,0	15,0	656	2,0	35,5	5,0	10,2	887	3,7	25,5
10,0	34,9	1038	3,8	80,0	10,0	25,6	1128	4,7	61,0	10,0	17,3	759	2,5	45,0	10,0	13,1	572	1,6	36,5	10,0	8,3	719	2,5	26,5
15,0	33,1	984	3,4	81,0	15,0	23,7	1047	4,1	62,5	15,0	15,5	676	2,0	46,0	15,0	11,2	486	1,2	37,0	15,0	6,3	547	1,6	27,5
20,0	31,3	932	3,1	82,0	20,0	21,9	966	3,6	63,5	20,0	13,5	592	1,6	47,0	20,0	9,1	398	0,8	38,0	20,0	4,1	359	0,8	28,0

V – air flow
 PT – heating capacity
 Tp1 – inlet air temperature
 Tp2 – outlet air temperature
 Tw1 – inlet water temperature

Tw2 – outlet water temperature
 Qw – water flow rate in heat exchanger
 Δpw – water pressure drop in heat exchanger



HEATING CAPACITY CALCULATOR

In order to select the device with other parameters scan QR code.

⁽¹⁾ Tp1 - air temperature at the inlet to the water exchanger. This is the result of the outside temperature (Tz), the degree of recirculation and temperature inside the room (Tw).

$Tp1 = (Tz \times V \text{ fresh air} + Tw \times V \text{ recirculated air}) / V$
 i.e. Tz = -20°C, Tw = 16°C, fresh air 70%, Tp1 = -9°C

HEATING CAPACITIES

Tw1 / Tw2 = 120/90°C					Tw1 / Tw2 = 90/70°C					Tw1 / Tw2 = 70/50°C					Tw1 / Tw2 = 60/40°C					Tw1 / Tw2 = 40/30°C				
Tp1	PT	Qw	Δpw	Tp2	Tp1	PT	Qw	Δpw	Tp2	Tp1	PT	Qw	Δpw	Tp2	Tp1	PT	Qw	Δpw	Tp2	Tp1	PT	Qw	Δpw	Tp2
[°C]	[kW]	[l/h]	[kPa]	[°C]	[°C]	[kW]	[l/h]	[kPa]	[°C]	[°C]	[kW]	[l/h]	[kPa]	[°C]	[°C]	[kW]	[l/h]	[kPa]	[°C]	[°C]	[kW]	[l/h]	[kPa]	[°C]
LEO XL3 + KM XL																								
3rd fan step: V = 3100 m³/h																								
-25,0	101,1	3008	13,5	81,0	-25,0	81,1	3578	19,7	60,0	-25,0	64,6	2826	13,6	42,5	-25,0	56,3	2452	10,9	34,0	-25,0	45,2	3921	27,1	22,5
-20,0	97,3	2 895	12,6	82,0	-20,0	77,3	3410	18,0	61,0	-20,0	60,8	2659	12,2	43,5	-20,0	52,4	2285	9,6	35,0	-20,0	41,4	3590	23,1	23,5
-15,0	93,5	2 783	11,7	83,0	-15,0	73,5	3 242	16,5	62,0	-15,0	57,0	2492	10,9	44,5	-15,0	48,6	2117	8,4	36,0	-15,0	37,6	3257	19,4	24,5
-10,0	89,7	2 670	10,8	83,5	-10,0	69,7	3 075	14,9	63,0	-10,0	53,1	2324	9,6	45,5	-10,0	44,7	1949	7,3	37,0	-10,0	33,7	2924	16,0	25,5
-5,0	85,9	2 558	10,0	84,5	-5,0	65,9	2 908	13,5	64,0	-5,0	49,3	2 156	8,4	46,5	-5,0	40,8	1 779	6,2	37,5	-5,0	29,9	2590	12,9	26,0
0,0	82,2	2 447	9,2	85,5	0,0	62,1	2 741	12,1	64,5	0,0	45,4	1 988	7,2	47,5	0,0	36,9	1 610	5,2	38,5	0,0	26,0	2 254	10,0	27,0
5,0	78,4	2 335	8,5	86,5	5,0	58,3	2 574	10,8	65,5	5,0	41,6	1 819	6,2	48,0	5,0	33,0	1 438	4,2	39,5	5,0	22,1	1 915	7,5	28,0
10,0	74,7	2 225	7,8	87,0	10,0	54,6	2 408	9,6	66,5	10,0	37,7	1 650	5,2	49,0	10,0	29,0	1 265	3,4	40,0	10,0	18,1	1 571	5,3	29,0
15,0	71,1	2 115	7,1	88,0	15,0	50,8	2 242	8,4	67,5	15,0	33,8	1 479	4,3	50,0	15,0	25,0	1 088	2,6	40,5	15,0	14,1	1 219	3,4	29,5
20,0	67,4	2 007	6,4	89,0	20,0	47,1	2 077	7,3	68,0	20,0	29,9	1 307	3,4	50,5	20,0	20,8	907	1,9	41,5	20,0	9,8	849	1,8	30,0
2nd step: V = 2200 [m³/h]																								
-25,0	77,2	2 299	8,2	89,0	-25,0	61,9	2 731	12,0	66,5	-25,0	49,4	2 163	8,4	48,0	-25,0	43,1	1 880	6,8	38,5	-25,0	34,5	2 994	16,7	26,0
-20,0	74,4	2 213	7,7	89,5	-20,0	59,0	2 603	11,0	67,0	-20,0	46,5	2 036	7,6	48,5	-20,0	40,2	1 753	6,0	39,5	-20,0	31,6	2 742	14,2	26,5
-15,0	71,5	2 128	7,2	90,5	-15,0	56,1	2 476	10,1	67,5	-15,0	43,6	1 909	6,7	49,5	-15,0	37,3	1 625	5,2	40,0	-15,0	28,7	2 490	12,0	27,5
-10,0	68,6	2 042	6,7	91,0	-10,0	53,2	2 349	9,2	68,5	-10,0	40,7	1 782	5,9	50,0	-10,0	34,3	1 497	4,5	40,5	-10,0	25,8	2 237	9,9	28,0
-5,0	65,8	1 957	6,2	91,5	-5,0	50,4	2 223	8,3	69,0	-5,0	37,8	1 654	5,2	50,5	-5,0	31,4	1 368	3,9	41,0	-5,0	22,9	1 984	8,0	28,5
0,0	62,9	1 873	5,7	92,0	0,0	47,5	2 096	7,5	69,5	0,0	34,9	1 527	4,5	51,0	0,0	28,4	1 239	3,2	41,5	0,0	19,9	1 729	6,3	29,5
5,0	60,1	1 789	5,2	93,0	5,0	44,6	1 970	6,7	70,5	5,0	32,0	1 398	3,9	52,0	5,0	25,4	1 108	2,7	42,0	5,0	17,0	1 471	4,7	30,0
10,0	57,3	1 705	4,8	93,5	10,0	41,8	1 844	5,9	71,0	10,0	29,0	1 269	3,3	52,5	10,0	22,4	976	2,1	42,5	10,0	13,9	1 209	3,3	30,5
15,0	54,5	1 623	4,4	94,0	15,0	39,0	1 719	5,2	71,5	15,0	26,1	1 140	2,7	53,0	15,0	19,3	841	1,6	43,0	15,0	10,8	939	2,1	30,5
20,0	51,8	1 541	4,0	94,5	20,0	36,1	1 594	4,6	72,0	20,0	23,1	1 009	2,2	53,0	20,0	16,1	701	1,2	43,0	20,0	7,5	650	1,1	31,0
1st fan step: V = 1300 m³/h																								
-25,0	49,8	1483	3,7	99,5	-25,0	39,8	1 758	5,4	74,5	-25,0	32,0	1 399	3,9	55,0	-25,0	28,0	1219	3,2	45,0	-25,0	22,3	1930	7,6	30,5
-20,0	48,0	1 429	3,5	99,5	-20,0	38,0	1 677	5,0	75,0	-20,0	30,1	1 318	3,5	55,0	-20,0	26,1	1138	2,8	45,0	-20,0	20,4	1769	6,5	31,0
-15,0	46,2	1 374	3,3	100,0	-15,0	36,2	1 596	4,6	75,0	-15,0	28,3	1 237	3,1	55,5	-15,0	24,2	1056	2,4	45,5	-15,0	18,6	1608	5,5	31,5
-10,0	44,3	1 320	3,0	100,5	-10,0	34,3	1 515	4,2	75,5	-10,0	26,4	1 156	2,8	56,0	-10,0	22,3	974	2,1	45,5	-10,0	16,7	1447	4,6	31,5
-5,0	42,5	1 265	2,8	100,5	-5,0	32,5	1 435	3,8	76,0	-5,0	24,6	1 074	2,4	56,0	-5,0	20,5	891	1,8	46,0	-5,0	14,8	1 285	3,7	32,0
0,0	40,7	1 212	2,6	101,0	0,0	30,7	1 354	3,4	76,0	0,0	22,7	993	2,1	56,5	0,0	18,5	808	1,5	46,0	0,0	12,9	1121	2,9	32,0
5,0	38,9	1 158	2,4	101,0	5,0	28,9	1 274	3,1	76,5	5,0	20,8	911	1,8	56,5	5,0	16,6	724	1,3	46,0	5,0	11,0	956	2,2	32,5
10,0	37,1	1 105	2,2	101,5	10,0	27,1	1 194	2,7	76,5	10,0	18,9	828	1,5	56,5	10,0	14,6	638	1,0	46,0	10,0	9,1	786	1,6	32,5
15,0	35,4	1 053	2,0	101,5	15,0	25,3	1 115	2,4	77,0	15,0	17,0	745	1,3	57,0	15,0	12,6	550	0,8	46,0	15,0	7,0	608	1,0	32,0
20,0	33,6	1 001	1,8	102,0	20,0	23,5	1 035	2,1	77,0	20,0	15,1	661	1,0	57,0	20,0	10,5	456	0,6	45,5	20,0	4,6	399	0,5	31,0

V – air flow
 PT – heating capacity
 Tp1 – inlet air temperature
 Tp2 – outlet air temperature
 Tw1 – inlet water temperature

Tw2 – outlet water temperature
 Qw – water flow rate in heat exchanger
 Δpw – water pressure drop in heat exchanger



HEATING CAPACITY CALCULATOR

In order to select the device with other parameters scan QR code.

⁽¹⁾ Tp1 - air temperature at the inlet to the water exchanger. This is the result of the outside temperature (Tz), the degree of recirculation and temperature inside the room (Tw).

$Tp1 = (Tz \times V \text{ fresh air} + Tw \times V \text{ recirculated air}) / V$
 i.e. Tz = -20°C, Tw = 16°C, fresh air 70%, Tp1 = -9°C

NOTES

NOTES

NOTES



ul. Chwaszczyńska 135
81-571 Gdynia, Poland

T: +48 58 627 57 20

for inquiries:
info@flowair.pl
www.flowair.com

