

Installation, use and maintenance manual

G gas unit heater

Condensing gas unit heaters for use in industrial and commercial installations

Powered by natural gas/LPG



Revision: K

Code: D-LBR565

This Installation, use and maintenance manual has been drawn up and printed by Robur S.p.A.; whole or partial reproduction of this Installation, use and maintenance manual is prohibited.

The original is filed at Robur S.p.A.

Any use of this Installation, use and maintenance manual other than for personal consultation must be previously authorised by Robur S.p.A. The rights of those who have legitimately filed the registered trademarks contained within this publication are not affected.

With the aim of continuously improving the quality of its products, Robur S.p.A. reserves the right to modify the data and contents of this Installation, use and maintenance manual without prior notice.

INDEX OF CONTENTS

I Introduction	p. 4	3.4 Flue gas condensate discharge.....	p. 20
I.1 Recipients	p. 4	4 Electrical installer	p. 20
I.2 Control device	p. 4	4.1 Warnings	p. 20
II Symbols and definitions	p. 4	4.2 Electrical systems	p. 21
II.1 Key to symbols.....	p. 4	4.3 Electrical power supply.....	p. 21
II.2 Terms and definitions.....	p. 4	4.4 Control system	p. 21
III Warnings	p. 4	4.5 Remote the fault signals.....	p. 23
III.1 General and safety warnings	p. 4	4.6 Remote the error reset	p. 24
III.2 Conformity	p. 5	5 First start-up	p. 24
III.3 Exclusions of liability and warranty.....	p. 6	5.1 Preliminary checks.....	p. 24
1 Features and technical data	p. 7	5.2 Combustion parameters check.....	p. 25
1.1 Features	p. 7	5.3 Gas changeover	p. 26
1.2 Dimensions	p. 8	6 Normal operation	p. 26
1.3 Electrical wiring diagram	p. 10	6.1 Warnings	p. 26
1.4 Controls	p. 11	6.2 Switch on and off	p. 26
1.5 Technical characteristics.....	p. 12	6.3 Chronothermostat.....	p. 27
2 Transport and positioning	p. 13	6.4 Gas unit heater operating modes	p. 33
2.1 Warnings	p. 13	6.5 Operating diagrams.....	p. 35
2.2 Handling.....	p. 13	6.6 Setting range.....	p. 36
2.3 Appliance positioning.....	p. 13	7 Maintenance	p. 37
2.4 Minimum clearance distances.....	p. 14	7.1 Warnings	p. 37
2.5 Support bracket.....	p. 14	7.2 Scheduled routine maintenance.....	p. 37
3 Heating engineer	p. 15	7.3 Resetting the temperature limit thermostat.....	p. 37
3.1 Warnings	p. 15	7.4 Troubleshooting.....	p. 38
3.2 Fuel gas supply	p. 15	7.5 Periods of inactivity.....	p. 38
3.3 Combustion products exhaust	p. 16	8 Appendices	p. 39
		8.1 Product fiche.....	p. 39

I INTRODUCTION



Manual

This Manual is an integral part of the G unit and must be handed to the end user together with the appliance.

I.1 RECIPIENTS

This Manual is intended for:

- ▶ End user, for appropriate and safe use of the appliance.
- ▶ Qualified installer, for correct appliance installation.
- ▶ Planner, for specific information on the appliance.

I.2 CONTROL DEVICE

To be able to operate, the G unit must be connected to the supplied chronothermostat (see Paragraph 1.4 p. 11).

II SYMBOLS AND DEFINITIONS

II.1 KEY TO SYMBOLS



DANGER



WARNING



NOTE



PROCEDURE



REFERENCE (to other document)

II.2 TERMS AND DEFINITIONS

Appliance / Unit = equivalent terms, both used to refer to the

gas unit heater.

TAC = Technical Assistance Centre authorised by Robur.

Chronothermostat = control device that integrates the functions of room temperature control, programmable timer and indication of any operating errors.

First start-up = appliance commissioning operation which may only and exclusively be carried out by a TAC.

III WARNINGS

III.1 GENERAL AND SAFETY WARNINGS



Installer's qualifications

Installation must exclusively be performed by a qualified firm and by skilled personnel, with specific knowledge on heating, electrical systems and gas appliances, in compliance with the laws in force in the Country of installation.



Declaration of conformity

Upon completing installation, the installing firm shall issue to the owner/client the appliance's workmanlike conformity declaration, according to national/local regulations in force and the manufacturer's instructions/provisions.



Misuse

The appliance must only be used for the purposes for which it has been designed. Any other use is deemed hazardous. Incorrect use may affect operation, duration and safety of the appliance. Adhere to the manufacturer's instructions.



Use of the appliance by children

The device can be used by children over 8 years old, and by people with reduced physical, sensory or mental capabilities, or lack of experience or knowledge, only if they are under surveillance or after they have received instructions regarding safe use of the appliance and understanding the dangers inherent in it. Children should not play with the appliance. Cleaning and maintenance that must be performed by the user must not be performed by unsupervised children.



Hazardous situations

- Do not start the appliance in hazardous conditions, such as: gas smell, problems with the electrical/gas system, parts of the appliance under water or damaged, malfunctioning, disabling or bypassing control and safety devices.
- In case of danger, request intervention by qualified personnel.
- In case of danger, switch off the electrical power and gas supplies only if this can be done in total safety.
- Do not entrust children, persons with physical, sensory or mental disabilities or persons with poor knowledge and experience with use of the appliance.

**Gas component tightness**

- Before performing any operation on gas ducting components, close the gas valve.
- Upon completing any procedure, perform the tightness test according to regulations in force.

**Gas smell**

If you smell gas:

- Do not use electrical devices such as telephones, multimeters or other equipment that may cause sparks next to the appliance.
- Shut off the gas supply by turning the valve off.
- Open immediately doors and windows to create a cross-current of air to purify the room.
- Disconnect electrical power supply by means of the external isolation switch in the power supply electrical panel.
- Use a telephone away from the appliance to ask for intervention from qualified personnel.

**Poisoning**

- Ensure the flue gas ducts are tightness and compliant with the regulations in force.
- Upon completing any procedure, ensure components are tightness.

**Moving parts**

The appliance contains moving parts.

- Do not remove guards during operation, and in any case prior to disconnecting the power supply.

**Burn hazard**

The appliance contains very hot parts.

- Do not open the appliance and do not touch internal components before the appliance has cooled down.
- Do not touch the flue gas exhaust before it has cooled down.

**Electrocution hazard**

- Disconnect the electrical power supply before any operation on appliance components.
- For electrical connections exclusively use compliant components and according to the specifications provided by the manufacturer.
- Ensure the appliance cannot be accidentally switched back on.

**Earthing**

Electrical safety depends on effective earthing system, correctly connected to the appliance and installed according to the regulations in force.

**Air flow**

Do not obstruct the fan intake or the hot air outlet.

**Distance from combustible or flammable materials**

- Do not deposit flammable materials (paper, diluents, paints, etc.) near the appliance.
- Comply with current regulations.

**Aggressive substances in air**

The air of the installation site must be free from aggressive substances.

**Acid flue gas condensate**

- Discharge the acid condensate of combustion flue gas, as indicated in Paragraph 3.4 p. 20, in compliance with current exhaust regulations.

**Switching the appliance off**

Disconnecting the power supply while the appliance is running may cause permanent damage to internal components.

- Except in the event of danger, do not disconnect the power supply to switch off the appliance, but always and exclusively act through the provided control device.

**In the event of failure**

Operations on internal components and repairs may exclusively be carried out by a TAC, using only original parts.

- In the event of failure of the appliance and/or breakage of any component, do not attempt to repair and/or restore and immediately contact the TAC.

**Routine maintenance**

Proper maintenance assures the efficiency and good operation of the appliance over time.

- Maintenance must be performed according to the manufacturer's instructions (see Chapter 7 p. 37) and in compliance with current regulations.
- Appliance maintenance and repairs may only be entrusted to firms legally authorised to work on gas appliances and systems.
- Enter into a maintenance contract with an authorised specialised firm for routine maintenance and for servicing in case of need.
- Use only original parts.

**Keep the Manual**

This Installation, use and maintenance manual must always accompany the appliance and must be handed to the new owner or installer in the event of sale or removal.

III.2 CONFORMITY

EU Directives and standards

The G series gas unit heaters are certified in accordance with European regulation GAR 426/2016/EU and meet the essential requirements of the following Directives:

- ▶ 2016/426/EU "Gas Appliances Regulation" as amended and added.
- ▶ 2014/30/EC "Electromagnetic Compatibility Directive" as amended and added.
- ▶ 2014/35/EC "Low Voltage Directive" as amended and added.
- ▶ 2006/42/EC "Machine Directive" as amended and added.
- ▶ 2281/2016/EU "Ecodesign requirements for air heating products" as amended and added.

Furthermore, they comply with the requirements of the following standards:

- ▶ EN 1020 Non-domestic forced convection gas-fired air heaters for space heating not exceeding a net heat input of 300 kW incorporating a fan to assist transportation of combustion air or combustion products.
- ▶ prEN 17082 Domestic and non-domestic gas-fired forced convection air heaters for space heating not exceeding a net heat input of 300 kW.

Other applicable provisions and standards

The design, installation, operation and maintenance of the systems shall be carried out in compliance with current applicable regulations, depending on the Country and location, and in accordance with the manufacturer's instructions. In particular, regulations regarding the following shall be complied with:

- ▶ Gas systems and equipment.
- ▶ Electrical systems and equipment.
- ▶ Heating systems.
- ▶ Environmental protection and combustion products exhaust.
- ▶ Fire safety and prevention.
- ▶ Any other applicable law, standard and regulation.

III.3 EXCLUSIONS OF LIABILITY AND WARRANTY



Any contractual or extra-contractual liability of the

manufacturer for any damage caused by incorrect installation and/or improper use and/or failure to comply with regulations and with the manufacturer's directions/instructions shall be disclaimed.



In particular, the warranty on the appliance may be rendered void by the following conditions:

- Incorrect installation.
- Misuse.
- Failure to comply with the manufacturer's indications on installation, use and maintenance.
- Alteration or modification of the product or any part thereof.
- Extreme operational conditions or however outside of the operational ranges set forth by the manufacturer.
- Damages caused by external agents such as salts, chlorine, sulphur or other chemical substances present in the air of the installation site.
- Abnormal actions transmitted to the appliance by the plant or installation (mechanical stresses, pressure, vibrations, thermal expansion, electrical surges...).
- Accidental damages or due to force majeure.

1 FEATURES AND TECHNICAL DATA

1.1 FEATURES

1.1.1 Operation

The G series gas unit heater is an independent heating appliance with airtight combustion circuit and forced air draft. It has been designed to be installed inside the room to be heated.

The combustion circuit is room sealed and meets the requirements for type C appliances: combustion air supply and flue gas exhaust discharge take place outdoors and are ensured by the functioning of a blower inserted in the combustion circuit.

The appliance is also approved for type B for installations where it is allowed to take the combustion air directly from the room to be heated.

The gas unit heater operation is controlled by a room thermostat, integrated in the supplied chronothermostat.

The gas unit heater operates by modulating the heat output and ventilation speed continuously.

Products of gas combustion (natural gas or LPG) flow internally through the heat exchangers, which are invested externally by the air current produced by the fan, delivering hot air flow into the room.

The fan operates automatically only when it receives the enabling signal from the fan thermostat, i.e. with hot heat exchangers, in order to avoid the introduction of cold air into the room, and it will switch off with cold exchangers.

The air flow direction is adjustable vertically by means of the revolving louvres of the grille.

If heat exchangers overheat due to malfunction, the temperature probe cuts off the power supply to the gas valve and drives the blower and the fan at maximum speed. If the temperature should increase further, the limit thermostat trip causes the gas unit heater to switch off.

A blower upline of the burner mixes the air and gas and expels the combustion fumes.

In the event of obstructions in the intake or exhaust duct, or in the event of malfunction of the blower, the electronic board will automatically modulate the gas unit heater heat output. In the event of obstructions or malfunction beyond the permitted range, the flue thermostat trip causes the gas valve to stop and the gas unit heater to be turned off.

The winter operation of the gas unit heater can be automatic or manual.

In summer it is possible to operate the fan only in order to provide a pleasant air flow within the room.

1.1.2 Mechanical components

- ▶ Pre-mix stainless steel burner.
- ▶ High head blower, with rotation speed modulation.
- ▶ Cylindrical stainless steel combustion chamber.
- ▶ Robur patented heat exchangers, made out of a special aluminium die-cast alloy, with horizontal finning on the air side and vertical finning on the flue gas exhaust side, with a very high heat exchange capacity.
- ▶ External steel panelling with epoxy powder enamel finish.
- ▶ Axial fan(s) with high air flow, with rotation speed variation.

1.1.3 Control and safety devices

- ▶ Electronic management board, with microprocessor and noise filter, which provides the following functions:
 - burner ignition
 - flame monitoring and modulation
 - blower management and blower speed control
 - fan speed control
 - heat exchanger temperature probe control
 - minimum flue gas temperature probe control
- ▶ 100 °C limit thermostat with manual reset against heat exchangers overheating.
- ▶ Flue thermostat.
- ▶ Gas solenoid valve.

1.2 DIMENSIONS

Figure 1.1 G30, G45, G60 gas unit heater dimensions

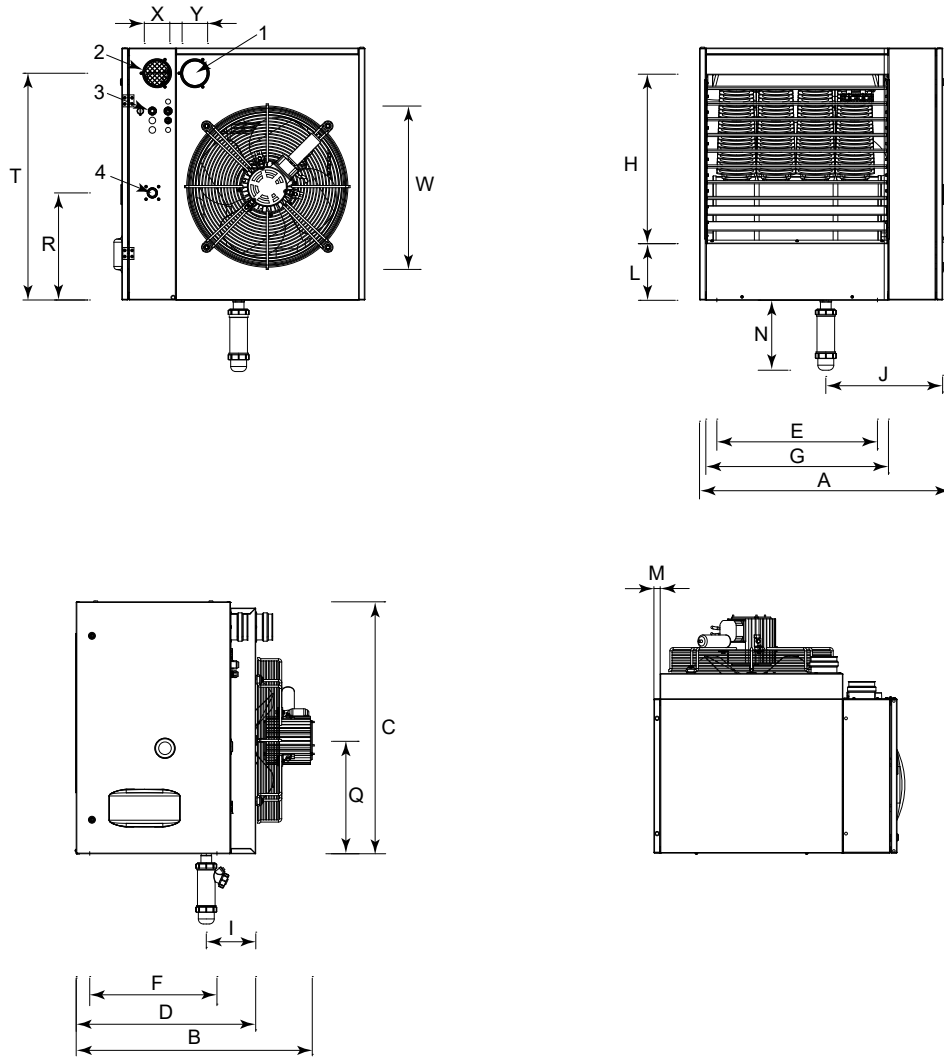

- 1 Flue gas exhaust
- 2 Combustion air inlet

- 3 Power supply cables input
- 4 Gas connection 3/4" F

Figure 1.2 G100 gas unit heater dimensions

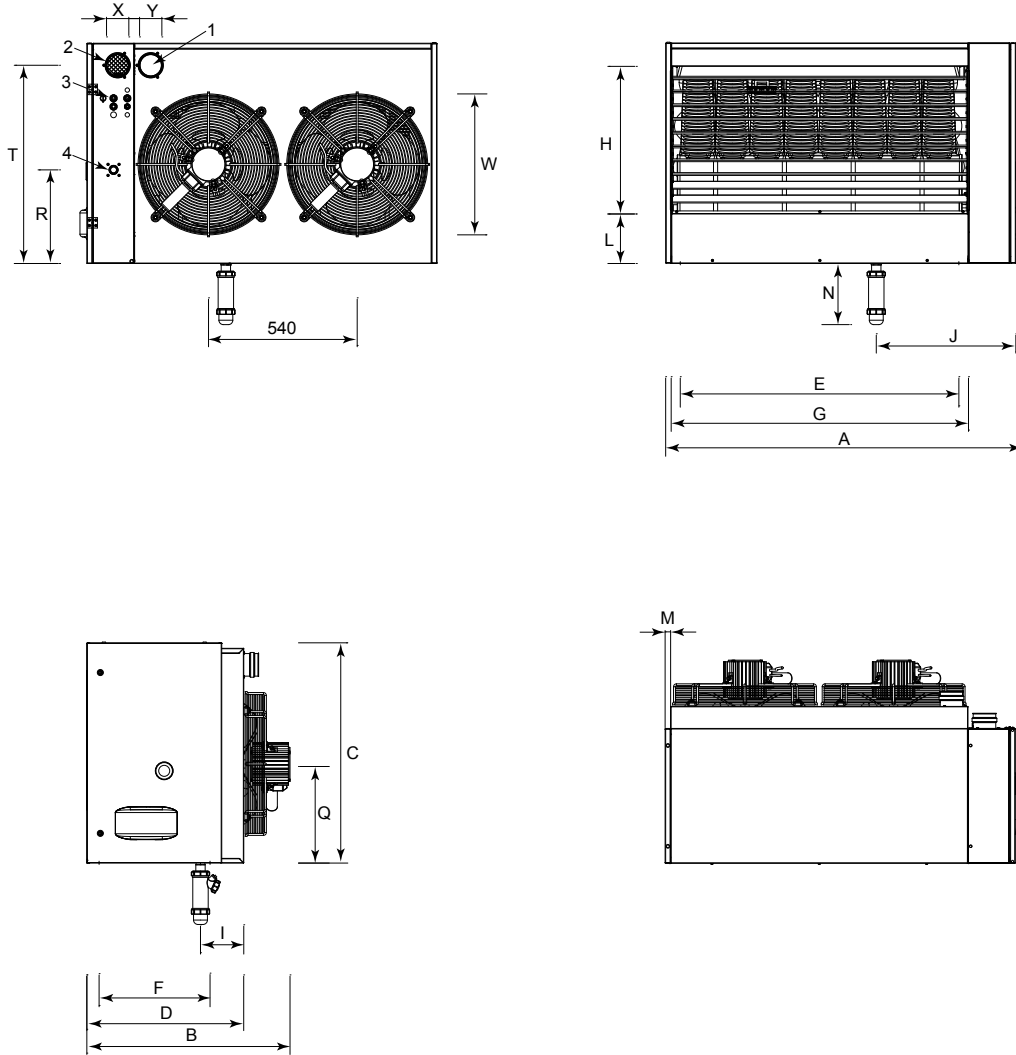

- 1 Flue gas exhaust
- 2 Combustion air inlet
- 3 Power supply cables input
- 4 Gas connection 3/4" F

Table 1.1 Dimensions

	G30	G45	G60	G100
A	656	706	796	1296
B	710	715	720	740
C	800	800	800	800
D	570	570	570	570
E	370	370	510	1010
F	405	405	405	405
G	440	490	580	1080
H	536	536	536	536
I	157,2	157,2	157,2	157,2
J	307	327	371	507
L	180	180	180	180
M	20	20	20	20
N	223	223	223	223
Q	360	360	360	360
R	340	340	340	340
T	720	720	720	720
W	380	480	500	520
X	80	80	80	80
Y	80	80	80	80

1.3 ELECTRICAL WIRING DIAGRAM

Figure 1.3 Electrical wiring diagram for G30, G45, G60

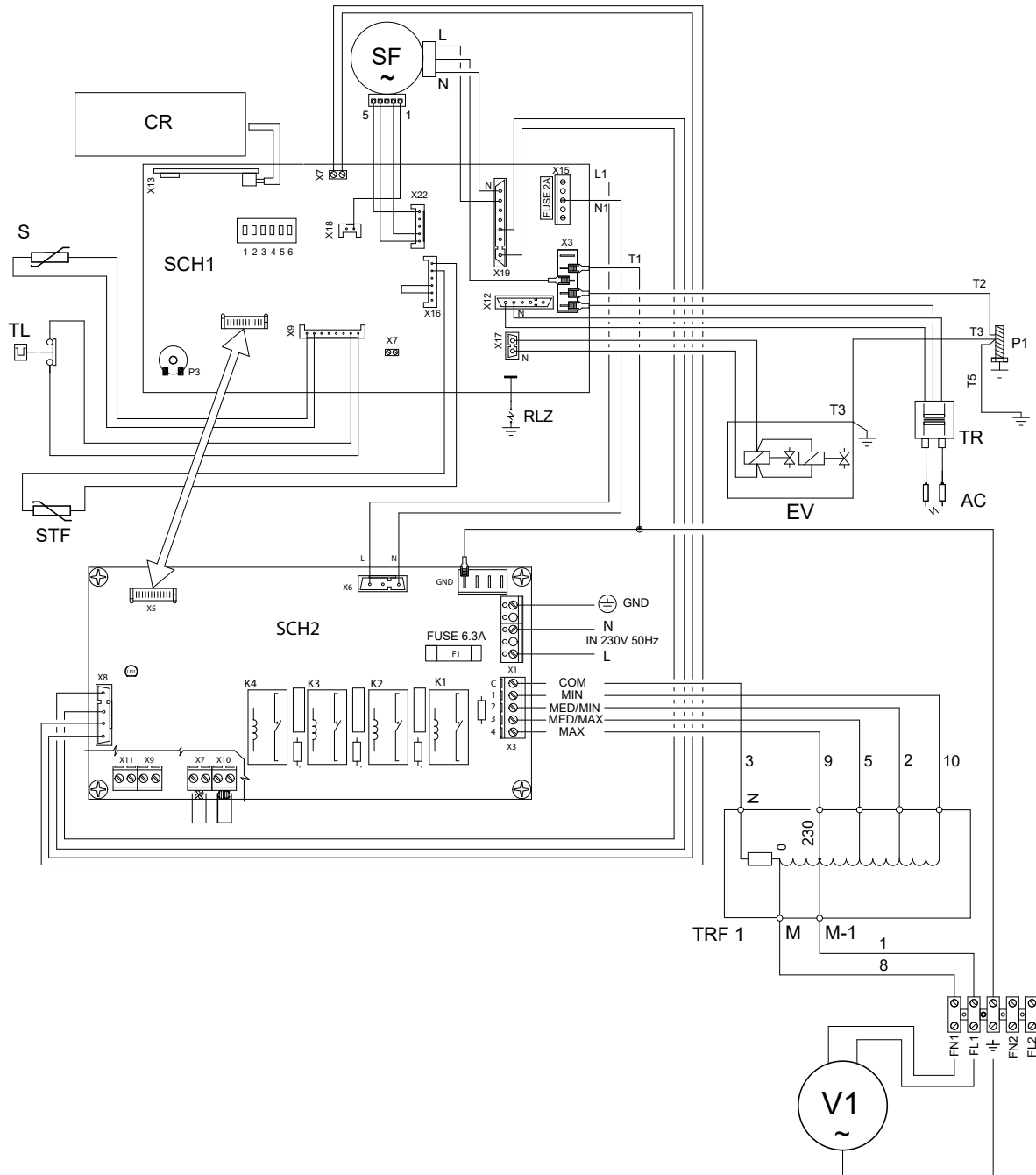

SF	Blower	STF	Flue gas temperature probe	3	Blue
SCH1	Control board	TL	Limit thermostat	4	Pink
SCH2	Motor board	AC	Ignition electrodes	5	Grey
S	Heat exchanger temperature probe	TRF1	Fan autotransformer	6	Yellow
RLZ	Flame sensor	P1	Earthing	7	Green
EV	Gas solenoid valve	CR	Chronothermostat	8	White
TR	Ignition transformer	1	Brown	9	Black
V1	Fan	2	Red	10	Purple

Figure 1.4 Electrical wiring diagram for G100

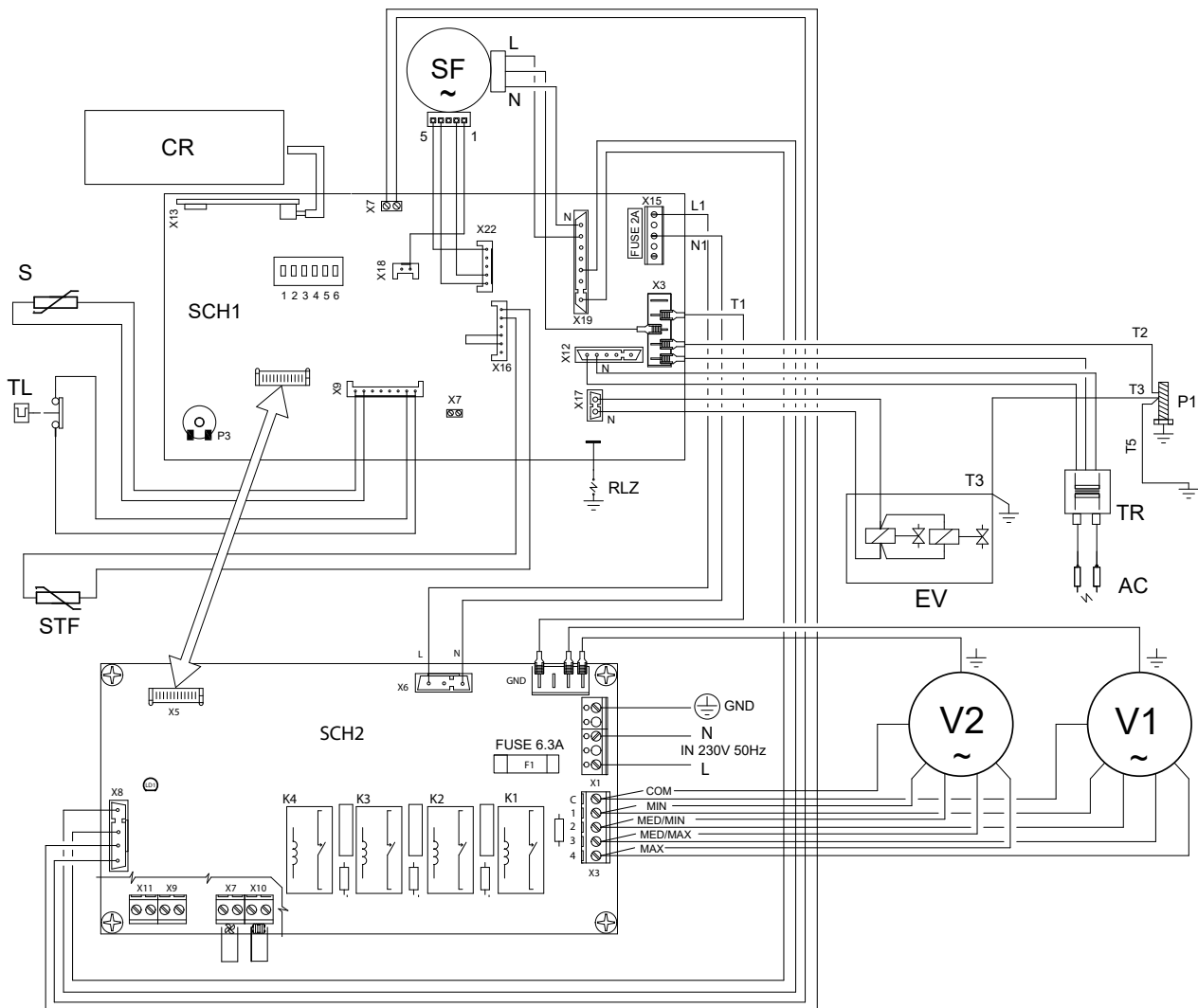

SF	Blower	STF	Flue gas temperature probe	4	Pink
SCH1	Control board	TL	Limit thermostat	5	Grey
SCH2	Motor board	AC	Ignition electrodes	6	Yellow
S	Heat exchanger temperature probe	P1	Earthing	7	Green
RLZ	Flame sensor	CR	Chronothermostat	8	White
EV	Gas solenoid valve	1	Brown	9	Black
TR	Ignition transformer	2	Red	10	Purple
V1-V2	Fan	3	Blue		

1.4 CONTROLS

chronothermostat.

For further information please refer to Paragraph 6.3 p. 27.

1.4.1 Control device

The unit operation is controlled by the supplied digital

1.5 TECHNICAL CHARACTERISTICS

Table 1.2 Technical characteristics

			G30	G45	G60	G100
Heating mode						
Heat input	nominal (1013 mbar - 15 °C) (1)	kW	30,0	45,0	58,0	93,0
	minimum (1)	kW	15,0		19,3	31,7
Heat output	nominal	kW	29,2	43,3	56,2	90,2
	minimum	kW	15,8	15,6	20,2	33,5
Efficiency	nominal heat input	%	97,3	96,5	97,0	
	minimal heat input	%	105,3	104,3	104,6	105,7
	useful at 100% heat input	%	96,8	96,0	96,5	
Heat loss	to flue in operation	%	2,70	3,50	3,00	
	to jacket in operation	%	0,50			
	in off mode	%	0,10			
Temperature rise	nominal air flow rate	K	29,0	32,0		31,0
	minimal air flow rate	K	22,0	15,0	14,0	18,0
length of throw (residual speed < 0,5 m/s) (2)		m	18,0	25,0	31,0	40,0
Ambient air temperature (dry bulb)	maximum	°C	35 (3)			
	minimum	°C	0			
Electrical specifications						
Power supply	voltage	V	230			
	type	-	single-phase			
	frequency	Hz	50			
Electrical power absorption	nominal	kW	0,21	0,33	0,58	1,00
fuse		A	6,3			
Installation data						
Gas consumption	G20 natural gas (nominal)	m ³ /h	3,17	4,76	6,14	9,84
	G25 (nominal)	m ³ /h	3,69	5,54	7,14	11,45
	G25.1 (nominal)	m ³ /h	3,69	5,53	7,13	11,43
	G25.3 (nominal)	m ³ /h	3,16	5,42	6,98	11,19
	G27 (nominal)	m ³ /h	3,87	5,81	7,49	-
	G2.350 (nominal)	m ³ /h	4,41	6,62	8,53	-
	G30 (nominal)	kg/h	2,37	3,55	4,57	7,33
	G31 (nominal)	kg/h	2,33	3,55	4,51	7,22
Air flow	nominal	m ³ /h	2840	3850	5050	8250
	minimum	m ³ /h	2050	2900	4000	5200
Gas connection	type	-	F			
	thread	"	3/4			
Flue gas exhaust	diameter (Ø)	mm	80			
	residual head	Pa	65	100	120	200
	type of installation	-	B23, C13, C33, C53, C63			
Combustion air intake connection	diameter (Ø)	mm	80			
maximum flow flue condensate		l/h	4,6	6,9	8,9	14,4
recommended height		m	3,0 ÷ 3,5			
sound power L_w (max)		dB(A)	79,0	85,5	89,5	
sound power L_w (min)		dB(A)	73,5	79,5	83,5	
sound pressure L_p at 5 metres (max)		dB(A)	57,0	63,5	67,5	
sound pressure L_p at 5 metres (min)		dB(A)	51,5	57,5	61,5	
Dimensions	depth	mm	710	715	720	740
	height	mm	800			
	width	mm	656	706	796	1296
Weight	in operation	kg	55	65	75	120
General information						
number of heat exchangers		-	2	3	4	8
type of heat exchangers		-	torre			
number of fans		-	1			2

(1) Relative to NCV (net calorific value).

(2) Values measured in an open area; in a real installation, the thermal flow may reach greater distances than those given here (depending on the height of the ceiling and its thermal insulation).

(3) The operating temperature of the appliance components is 0 °C / +60 °C.

2 TRANSPORT AND POSITIONING

2.1 WARNINGS

Damage from transport or installation

The manufacturer shall not be liable for any damage during appliance transport and installation.

On-site inspection

- Upon arrival at the site, ensure there is no transport damage on packing, metal panels or chronothermostat.
- After removing the packing materials, ensure the appliance is intact and complete.

Packing

- Only remove the packing after placing the appliance on site.
- Do not leave parts of the packing within the reach of children (plastic, polystyrene, nails...) since they are potentially dangerous.

Weight

- The lifting equipment must be suitable for the load.
- Lift up the unit and secure it to its support bracket (Paragraph 2.5 p. 14).

2.2 HANDLING

2.2.1 Handling and lifting

- ▶ Always handle the appliance in its packing, as delivered by the factory.
- ▶ Comply with safety regulations at the installation site.

Figure 2.1 Airflow distribution

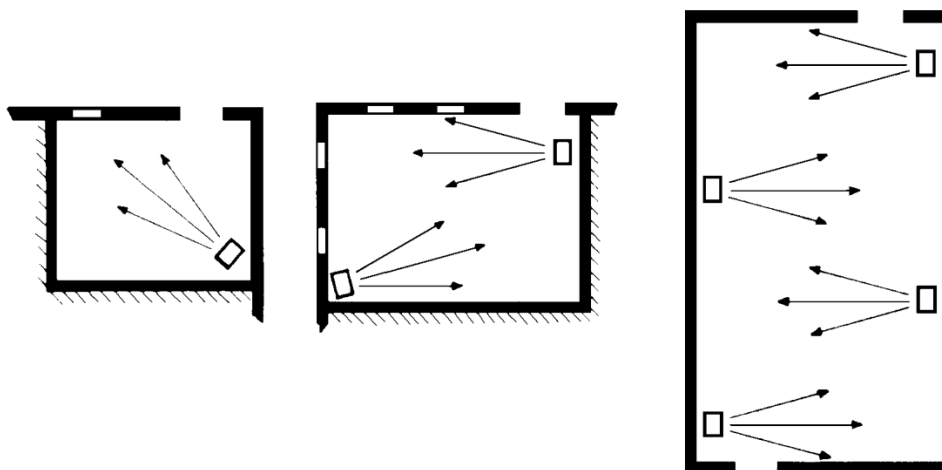



2.3 APPLIANCE POSITIONING

The unit must be installed in the room to be heated.

2.3.1 Where to install the appliance

 The wall or structure on which the unit is to be installed must be load-bearing or, in any case, suitable for supporting its weight.

 Installation must not be made on walls with poor strength that do not guarantee adequate resistance to the stresses produced by the unit. The manufacturer does not assume any responsibility if the appliance is installed on surfaces or walls that are not suitable for supporting its weight.

 The appliance's flue gas exhaust must not be immediately close to openings or air intakes of buildings, and must comply with safety and environmental regulations.

To obtain the maximum system efficiency it is advisable to comply with the following rules:

- ▶ Make sure that the air flow does not directly impinge on the staff (by tilting the grille louveres appropriately).
- ▶ Take any obstacles into account (pillars or other).
- ▶ Consider length of throw of the unit (Table 1.2 p. 12).
- ▶ For better heat distribution in the case of multiple unit installations, create alternate flows of hot air (see Figure 2.1 p. 13).
- ▶ In some cases it may also be suitable to place the units close to the main doors, so that they can also operate as air barriers when doors are opened.

2.4 MINIMUM CLEARANCE DISTANCES

2.4.1 Distances from combustible or flammable materials

- Keep the appliance away from combustible or flammable materials or components, in compliance with applicable

regulations.

2.4.2 Clearances around the appliance



 The minimum clearance distances are required for safety, operation and maintenance.

Figure 2.2 Clearances

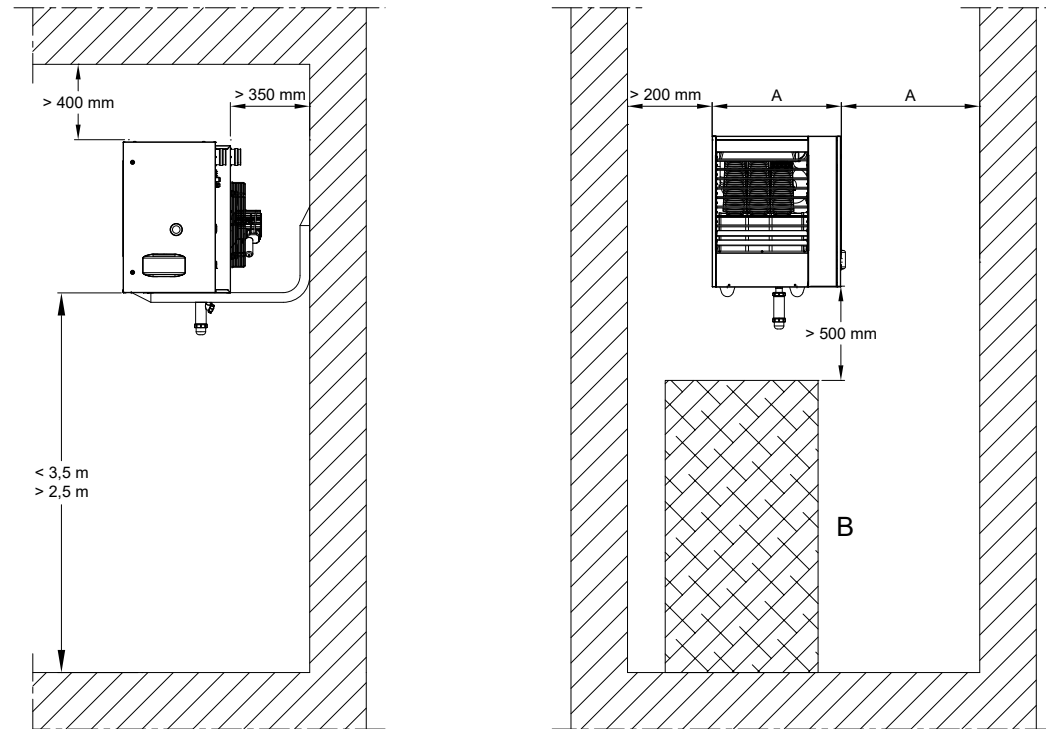

A Gas unit heater width

B Object or structure underneath the gas unit heater

 The recommended height from the floor to the gas unit heater base is 2,5 to 3,5 m (see Figure 2.2 p. 14). We do not recommend installing the gas unit heaters at heights below 2,5 m from the floor.

2.5 SUPPORT BRACKET

Robur provides easy mounting support brackets as an optional, suitably designed for G series gas unit heaters, which allow simplifying the wall fixing.

The following support brackets are available:

- O19800020 revolving wall support bracket (G30, G45 models)
- O19800024 revolving wall support bracket (G60 model)
- O19800028 revolving wall support bracket (G100 model)
- OSTF009 support bracket 1,4 m length

All support brackets are supplied with bolts and the rear support plate.

Mounting instructions are detailed in the literature supplied with these optional kits.

If you do not want to use these options, refer to Figure 2.3 p. 14. When fixing the unit to the support brackets, use 4 M10 bolts.

Figure 2.3 Installation with support bracket

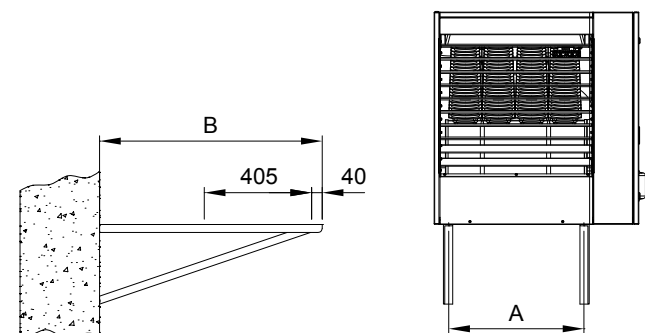

A Gas unit heater fixing points centre distance

B Support bracket length

Table 2.1 Support bracket dimensions

	G30	G45	G60	G100
A	370	370	510	1010
B	840			

3 HEATING ENGINEER

3.1 WARNINGS

3.1.1 General warnings



Read the warnings in Chapter III.1 *p. 4*, providing important information on regulations and on safety.



Compliance with installation standards

Installation must comply with applicable regulations in force, based on the installation Country and site, in matters of safety, design, implementation and maintenance of:

- heating systems
- gas systems
- flue gas exhaust
- flue gas condensate discharge



Installation must also comply with the manufacturer's provisions.

3.2 FUEL GAS SUPPLY

3.2.1 Gas connection

- ▶ 3/4" F

on the rear, to the left (see dimensional diagrams, Paragraph 1.2 *p. 8*).

- ▶ Install an anti-vibration connection between the appliance and the gas piping.

3.2.2 Mandatory shut-off valve

- ▶ Provide a gas shut-off valve (manual) on the gas supply line, next to the appliance, to isolate it when required.
- ▶ Provide a three-piece pipe union.
- ▶ Perform connection in compliance with applicable regulations.

3.2.3 Gas pipes sizing

The gas pipes must not cause excessive pressure drops and, consequently, insufficient gas pressure for the appliance.

3.2.4 Supply gas pressure



This appliance is equipped for a maximum gas supply pressure of 50 mbar.

The appliance's gas supply pressure, both static and dynamic, must comply with Table 3.1 *p. 15*, with tolerance $\pm 15\%$.



Non compliant gas pressure (Table 3.1 *p. 15*) may damage the appliance and be hazardous.

Table 3.1 Gas network pressure

Product category	Countries of destination	Gas supply pressure [mbar]							
		G20	G25	G25.1	G25.3	G2.350	G27	G30	G31
I ₂ H3B/P	AL, BG, CH, CY, CZ, DK, EE, FI, GR, HR, IT, LT, LV, MK, NO, RO, SE, SI, SK, TR	20						30	30
	AT, CH	20						50	50
I ₂ H3P	AL, BG, CH, CZ, ES, GB, GR, HR, IE, IT, LT, LV, MK, PT, SI, SK, TR	20							37
	RO	20							30
	AT	20							50
I ₂ ELL3B/P	DE	20	20					50	50
I ₂ ESi3P	FR	20	25						37
I ₂ ET3P		20							37
I ₂ H3B/P	HU	25						30	30
I ₂ H53B/P		25		25				30	30
I ₂ E3P	LU	20							50
I ₂ L3B/P	NL		25					30	30
I ₂ L3P			25						37
I ₂ EK3B/P		20			25			30	30
I ₂ EK3P		20			25				30
I ₂ E3B/P		20						37	37
I ₂ E	PL	20							
I ₂ ELWLS3B/P		20				13	20	37	37
I ₂ ELWLS3P		20				13	20		37
I ₂ E(R)	BE	20	25						
I ₂ E(S)		20	25						
I ₃ P									37
I ₃ P	IS								30
I ₂ H	LV	20							

I _{3B} /P	MT							30	30
I _{3B}								30	

The appliance gas supply pressure, both static and dynamic, must comply with the values in the Table, with a tolerance of ± 15%.

3.2.5 Vertical pipes and condensate

- ▶ Vertical gas pipes must be fitted with siphon and discharge of the condensate that may form inside the pipe.
- ▶ If necessary, insulate the piping.

3.2.6 LPG pressure reducers

With LPG the following must be installed:

- ▶ A first stage pressure reducer, close to the liquid gas tank.
- ▶ A second stage pressure reducer, close to the appliance.

3.3 COMBUSTION PRODUCTS EXHAUST



Compliance with standards

The appliance is approved for connection to a combustion products exhaust duct for the types shown in Table 1.2 p. 12.

3.3.1 Flue gas exhaust connection

- ▶ Ø 80 mm with gasket, on the rear, at the top (see dimensional diagrams, Paragraph 1.2 p. 8).

3.3.2 Combustion air intake fitting

- ▶ Ø 80 mm with gasket, on the rear, at the top (see dimensional diagrams, Paragraph 1.2 p. 8).

3.3.3 Installation types



The lengths in following Tables are intended for installations where the air and/or flue gas exhaust ducts follow linear paths as shown in the respective Figures. Otherwise, you must proceed with the calculation of the pressure drop (Paragraph 3.3.4 p. 18).



If ducts other than those supplied by the manufacturer are used, make sure that they are suitable for the unit on which they are installed. In particular, the temperature class of the duct must be appropriate for the operating characteristics of the unit, and must also respect the chemical-physical stability of the system itself.



The material used for the flue gas exhaust duct must be class W1 according to EN 1443 and therefore suitable to withstand the action of condensate of combustion products from gaseous fuels.



In any case, use approved ducts according to the type of installation to be made. Upon request, Robur can supply rigid pipes, coaxial ducts and terminals, all of approved type.

Gas unit heaters of the G series can be installed to one of the following options.

3.3.3.1 B23 type installation with wall flue gas exhaust pipe

Figure 3.1 B23 type installation with Ø 80 flue gas exhaust pipe

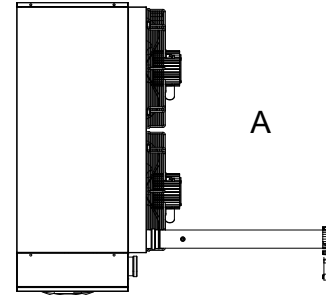

A View from above

Table 3.2 B23 type maximum allowed length

	Indicative maximum lengths (m)		
	Flue gas exhaust pipe		
	Ø 80	Ø 100	Ø 110
G30	23	30	30
G45	16	30	30
G60	12	30	30
G100	8	28	30

3.3.3.2 B23 type installation with roof flue gas exhaust pipe

Figure 3.2 B23 type installation with Ø 80 roof flue gas exhaust pipe

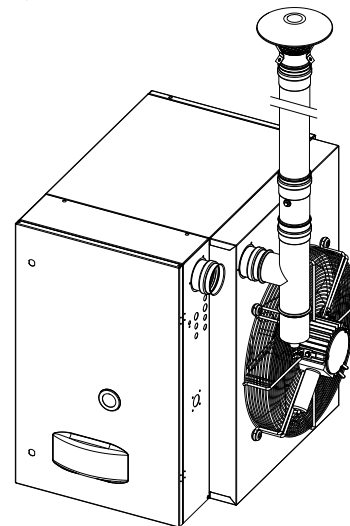

Table 3.3 B23 type maximum allowed length with roof flue gas exhaust pipe

	Indicative maximum lengths (m)		
	Flue gas exhaust pipe		
	Ø 80	Ø 100	Ø 110
G30	20	30	30
G45	13	30	30
G60	9	30	30
G100	5	18	28

3.3.3.3 C13 type installation with separate ducts

Figure 3.3 C13 type installation with Ø 80 separate ducts

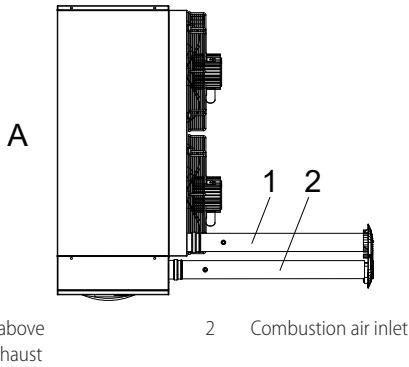

Table 3.4 C13 type maximum allowed length with separate ducts

	Indicative maximum lengths (m)					
	Air pipe			Flue gas exhaust pipe		
	Ø 80	Ø 100	Ø 110	Ø 80	Ø 100	Ø 110
G30	17	30	30	17	30	30
G45	12	30	30	12	30	30
G60	9	30	30	9	30	30
G100	6	21	20	6	21	20

3.3.3.4 C13 type installation with wall coaxial terminal

Figure 3.4 C13 type installation with wall coaxial terminal and Ø 80 ducts

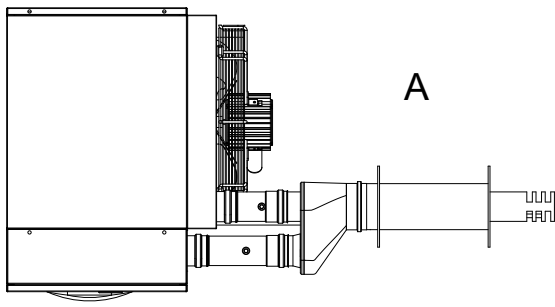

Table 3.5 C13 type maximum allowed length with 80/125 wall coaxial terminal and Ø 80 ducts

	Indicative maximum lengths (m)	
	Air pipe	Flue gas exhaust pipe
G30	11	11
G45	7	7
G60	4	4
G100	2	2

Table 3.6 C13 type maximum allowed length with 130/180 wall coaxial terminal

	Indicative maximum lengths (m)			
	Air pipe		Flue gas exhaust pipe	
	Ø 80	Ø 130	Ø 80	Ø 130
G30	13	30	13	30
G45	9	30	9	30
G60	6	30	6	30
G100	4	30	4	30

3.3.3.5 C33 type installation with roof coaxial terminal

Figure 3.5 C33 type installation with roof coaxial terminal

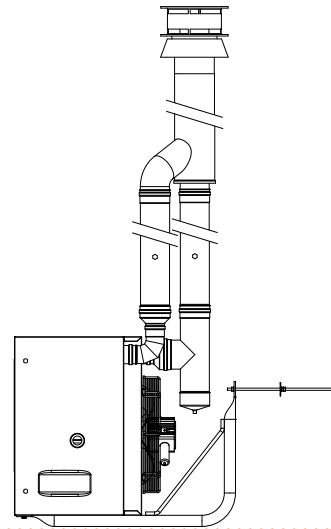

Table 3.7 C33 type maximum allowed length with 80/125 roof coaxial terminal and Ø 80 ducts

	Indicative maximum lengths (m)	
	Air pipe	Flue gas exhaust pipe
G30	8	8
G45	3	3
G60	-	-
G100	-	-

Table 3.8 C33 type maximum allowed length with 100/150 roof coaxial terminal

	Indicative maximum lengths (m)			
	Air pipe		Flue gas exhaust pipe	
	Ø 80	Ø 100	Ø 80	Ø 100
G30	11	30	11	30
G45	7	26	7	26
G60	4	17	4	17
G100	1	8	1	8

Table 3.9 C33 type maximum allowed length with 130/210 roof coaxial terminal

	Indicative maximum lengths (m)					
	Air pipe			Flue gas exhaust pipe		
	Ø 80	Ø 110	Ø 130	Ø 80	Ø 110	Ø 130
G30	13	30	30	13	30	30
G45	9	30	30	9	30	30
G60	5	30	30	5	30	30
G100	2	22	30	2	22	30

3.3.3.6 C53 type installation with separate ducts

Figure 3.6 C53 type installation with Ø 80 separate ducts

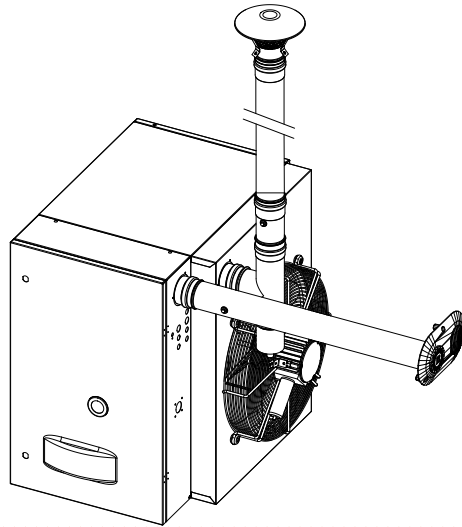

Table 3.10 C53 type maximum allowed length with separate ducts

	Indicative maximum lengths (m)			
	Air pipe	Flue gas exhaust pipe		
		Ø 80	Ø 100	Ø 110
G30	1	19	30	30
G45	1	13	30	30
G60	1	9	30	30
G100	1	5	24	30

3.3.4 Sizing and installing combustion air/exhaust fumes ducts

In order to dimension the duct system, the total pressure drop of

Table 3.11 Data for the calculation of the air/fumes system with pipes found on the market

				G30	G45	G60	G100
Installation data							
Flue temperature	Nominal heat input	G20	°C	85,0	95,0		85,0
Fumes flow rate	Nominal heat input	G20	kg/h	51	76	102	155
CO₂ percentage in fumes	Nominal heat input	G20	%	8,8	9,1	8,9	9,5
Flue gas exhaust	residual head		Pa	65	100	120	200

Table 3.12 Data for the calculation of the air/fumes system with Ø 80/110/130 pipes available as optional

				G30	G45	G60	G100
Flue gas exhaust pressure drop							
Ø 80 mm	Pipe	1 m	Pa	2,8	5,9	9,3	22,4
	Elbow	90°	Pa	3,6	7,8	12,7	31,6
	Tee		Pa	8,5	17,7	27,9	67,2
Ø 110 mm	Pipe	1 m	Pa	0,6	1,2	1,9	4,6
	Elbow	90°	Pa	1,0	2,2	3,5	8,6
	Tee		Pa	1,8	3,7	5,8	13,8
Ø 130 mm	Pipe	1 m	Pa	0,3	0,5	0,9	2,0
	Elbow	90°	Pa	0,5	1,1	1,8	4,4
	Tee		Pa	0,8	1,6	2,6	6,1
Air intake pressure drop							
Ø 80 mm	Pipe	1 m	Pa	1,0	2,0	3,2	7,5
	Elbow	90°	Pa	1,4	3,0	4,9	12,3
	Tee		Pa	2,9	6,1	9,5	22,6
Ø 110 mm	Pipe	1 m	Pa	0,2	0,4	0,7	1,6
	Elbow	90°	Pa	0,4	0,8	1,4	3,4
	Tee		Pa	0,6	1,3	2,0	4,7

the system must be calculated.

The total allowed pressure drop in the flue gas exhaust system depends on the unit model (Table 3.11 p. 18).

The pressure drops of the flue and air pipes available as Robur optional are shown in Table 3.12 p. 18.

Table 3.13 p. 19 shows the pressure drops for Ø 100 flue and air pipes in aluminium, available on the market.

The pressure drops of the coaxial pipes available as Robur optional are shown in Table 3.14 p. 19.

Resistance from the separate terminals are negligible since they are very low.

When designing, it must be checked that the total pressure drop of the piping system is lower than the maximum pressure drop allowed for the unit (Table 3.11 p. 18). An example of how to calculate pressure drops is given in Paragraph 3.3.5 p. 20.

The maximum lengths of air and flue gas exhaust pipes, depending on the type of installation, are shown in tables under the installation type figures, described in Paragraph 3.3.3 p. 16.



The above lengths are intended to be approximate values for standard installations where the air and flue gas exhaust ducts follow linear paths as shown in the respective figures. Otherwise, you must proceed with the calculation of the pressure drop (Paragraph 3.3.5 p. 20): installation will be permitted if the total pressure drop is lower than the maximum admissible pressure drop (Table 3.11 p. 18).



The Ø 80, 110 and 130 pipes and the coaxial pipes available as Robur optional are made of stainless steel, while the Ø 100 pipes available on the market are made of aluminium.

				G30	G45	G60	G100
Ø 130 mm	Pipe	1 m	Pa	0,1	0,2	0,3	0,7
	Elbow	90°	Pa	0,2	0,4	0,7	1,7
	Tee		Pa	0,3	0,6	0,9	2,1

Table 3.13 Data for the calculation of the air/fumes system with Ø 100 pipes

				G30	G45	G60	G100
Flue gas exhaust pressure drop							
Ø 100 mm	Pipe	1 m	Pa	0,9	1,9	3,0	7,1
	Elbow	90°	Pa	1,4	3,1	4,9	12,3
	Tee		Pa	2,8	5,7	9,0	21,2
Air intake pressure drop							
Ø 100 mm	Pipe	1 m	Pa	0,3	0,7	1,0	2,4
	Elbow	90°	Pa	0,5	1,2	2,0	4,9
	Tee		Pa	1,0	2,0	3,1	7,3

Table 3.14 Data for the calculation of the air/fumes system with coaxial pipes available as optional

				G30	G45	G60	G100
Coaxial exhaust pipe pressure drop							
Ø 80/125 mm	wall	Pa		21,2	40,3	60,8	132,4
	roof	Pa		23,8	50,5	-	-
Ø 130/180 mm	wall (1)	Pa		14,0	22,4	31,2	60,8
Ø 100/150 mm	roof	Pa		9,7	21,3	35,3	90,5
Ø 130/210 mm	roof	Pa		3,6	7,8	12,7	31,6

(1) Can be used only with OSTF009 support bracket



In the case of horizontal flue gas exhaust pipes installations, the following instructions must be observed:

- Length of the flue pipe < 1 m: install the flue pipe with a counter slope of 2 or 3 cm towards the gas unit heater (Figure 3.7 p. 19).
- Length of the flue pipe > 1,5 m: the condensate produced by the exhaust duct must be properly collected and drained by a suitable discharge system, in accordance with the applicable regulations in force.



If vertical flue gas exhaust pipes longer than 1,5 m are installed, at the base of the vertically mounted flue gas exhaust pipe a T-shaped piece must be fitted to collect the condensate, to prevent any condensate drops from entering the gas unit heater (Figure 3.2 p. 16).



For each 45° elbow an increment of 1,2 m in length should be added.

Figure 3.7 Horizontal pipe counter-slope

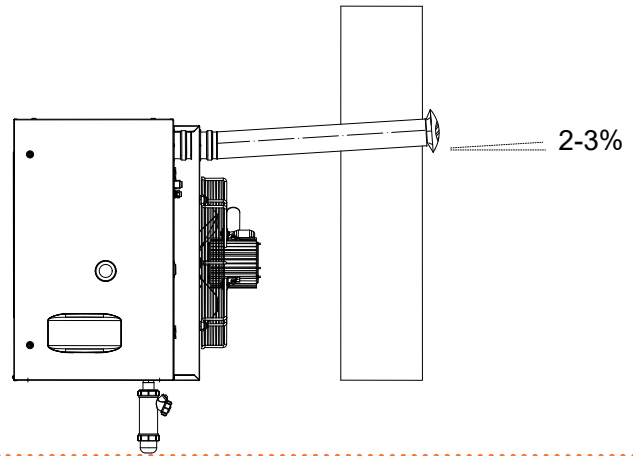

For proper installation of the wall external terminals for the flue gas exhaust and combustion air intake, follow the details given in Figure 3.8 p. 19.

Figure 3.8 Wall terminal position

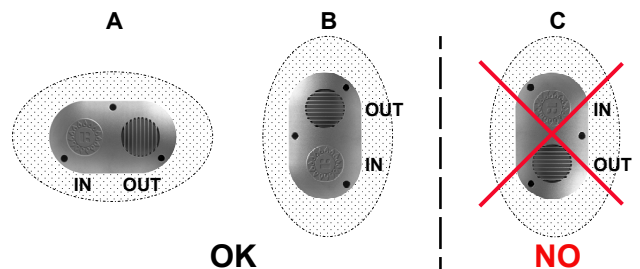

IN combustion air intake (OK)
 OUT flue gas exhaust B allowed position (OK)
 A recommended position C position NOT allowed (NO)

3.3.5 Example of calculation

Let's assume to install a G100 in C13 type installation (Figure 3.3 p. 17). The air/fumes system will be realized with Ø 80 separate pipes in the following way:

- ▶ 7 m of Ø 80 flue gas exhaust pipe
- ▶ 1 90° Ø 80 elbow on the flue gas exhaust pipe
- ▶ 6 m of Ø 80 air pipe

It is therefore possible to proceed with the verification, remembering that the maximum allowed pressure drop is 200 Pa (Table 3.11 p. 18).

- ▶ Ø 80 flue gas exhaust pipe
7 m x 22,4 Pa/m = 156,8 Pa
- ▶ 90° elbow
1 x 31,6 Pa = 31,6 Pa
- ▶ Ø 80 air pipe
6 m x 7,5 Pa/m = 45,0 Pa

Total pressure drop = 233,4 Pa

Total pressure drop of the piping system is greater than the maximum allowed pressure drop (200 Pa), therefore the installation is not allowed.

The installation can be done if one of the following steps is taken:

- ▶ Reduce the length of the air/fumes pipes.
- ▶ Increase pipe diameter, e.g. by using Ø 110. In this case the total pressure drop would be:

$$7 \text{ m} \times 4,6 \text{ Pa/m} = 32,2 \text{ Pa}$$

$$1 \times 8,6 \text{ Pa} = 8,6 \text{ Pa}$$

$$6 \text{ m} \times 1,6 \text{ Pa/m} = 9,6 \text{ Pa}$$

Total pressure drop = 50,4 Pa

which is therefore compatible with the maximum allowed pressure drop.

3.4 FLUE GAS CONDENSATE DISCHARGE

The G unit is a condensing appliance and therefore produces condensation water from combustion flue gases.



Condensate acidity and exhaust regulations

The flue gas condensate contains aggressive acid substances. Refer to applicable regulations in force for condensate exhaust and disposal.

- If required, install an acidity neutraliser of adequate capacity.



Do not use gutters to discharge the condensate

Do not discharge the fume condensate in gutters, due to the risk of materials corrosion and ice formation.

3.4.1 Flue gas condensate connection

The fitting for the flue gas condensate discharge is located in the lower part of the appliance.

- ▶ The condensate discharge pipe must be connected to a suitable discharge manifold.
- ▶ The junction between the pipe and the manifold must

remain visible.

3.4.2 Condensate discharge installation

A condensate drain kit is supplied as standard and must be connected (by the installer) to the appropriate outlet in the lower part of the gas unit heater.



How to install the condensate drain kit

1. Unscrew the upper seal of the condensate drain siphon.
2. Insert the condensate discharge connection neck ring into the upper seal with the connection towards the outside.
3. Screw the seal back onto the siphon.
4. Screw the siphon onto the condensate drain at the bottom of the gas unit heater.
5. Adjust the siphon so that the outlet port of the siphon is facing the intended path of the drain pipe (Figure 3.9 p. 20).



The output in the lower part of the appliance has been designed so that it remains usable even in case of mounting of the revolving wall support bracket (optional, Paragraph 2.5 p. 14).



The connection of the discharge to the sewerage system must be made at atmospheric pressure, i.e. by dripping into a siphoned container connected to the sewerage system.

Figure 3.9 Detail of the installation of the condensate discharge siphon

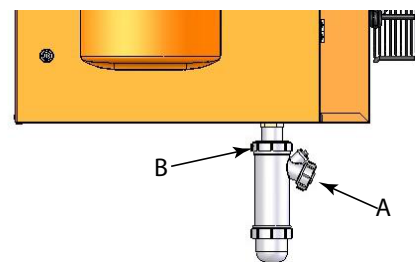

- A Condensate discharge connection (to be provided by the installer)
- B Upper seal

3.4.3 Flue gas condensate discharge manifold

To make the condensate drain manifolds:

- ▶ Size the ducts for maximum condensation capacity (Table 1.2 p. 12).
- ▶ Use plastic materials resistant to acidity pH 3-5.
- ▶ Provide for min. 1% slope, i.e. 1 cm for each m of the length (otherwise a booster pump is required).
- ▶ Prevent icing.

4 ELECTRICAL INSTALLER

4.1 WARNINGS



General warnings

Read the warnings in Chapter III p. 4, providing

important information on regulations and on safety.



Compliance with installation standards

Installation must comply with applicable regulations in force, based on the installation Country and site, in

matters of safety, design, implementation and maintenance of electrical systems.

 Installation must also comply with the manufacturer's provisions.

Live components

- After placing the appliance in the final position, and prior to making electrical connections, ensure not to work on live components.

Earthing

- The appliance must be connected to an effective earthing system, installed in compliance with regulations in force.
- It is forbidden to use gas pipes as earthing.

Cable segregation

Keep power cables physically separate from signal ones.

Do not use the power supply switch to turn the appliance on/off

- Never use the power supply switch to turn the appliance on and off, since it may be damaged in the long run (occasional blackouts are tolerated).
- To turn the appliance on and off, exclusively use the suitably provided control device.

4.2 ELECTRICAL SYSTEMS

Electrical connections provide:

- Power supply (Paragraph 4.3 p. 21).
- Control system (Paragraph 4.4 p. 21).

How to make connections

All electrical connections must be made on the electronic control board in the electrical panel of the unit:

1. Ensure the appliance is not live.
2. To access the electrical board open the door on the right side of the unit.
3. Insert cables through cable gland (detail 3 on dimensional diagrams, Paragraph 1.2 p. 8).
4. Identify the appropriate connection terminals.
5. Make the connections.
6. Close the door.

4.3 ELECTRICAL POWER SUPPLY

4.3.1 Power supply line

Provide (by the installer) a protected single phase line (230 V 1-N 50 Hz) with:

- ▶ H05 VVF 3x1,5 mm² type cable with a maximum external diameter of 12 mm.
- ▶ Bipolar disconnector with minimum contact opening of 3 mm.

How to connect the power supply

To connect the three-pole power supply cable:

1. Access the electronic board according to Procedure 4.2 p. 21.
2. Connect the three wires to the electronic board as shown in Figure 4.1 p. 21.
3. Provide the earth lead-in wire longer than live ones (last to be torn in the event of accidental pulling).

Figure 4.1 Appliance connection to the mains power supply

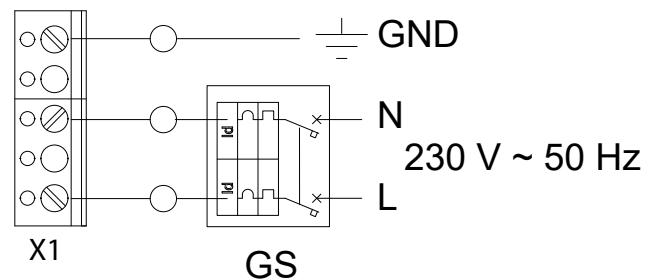

L phase
N neutral

Components NOT SUPPLIED:
GS two-pole switch

4.4 CONTROL SYSTEM

4.4.1 Positioning the control system

Install the chronothermostat according to the following guidelines:

- ▶ At about 1,5 m from the floor, protected against air draughts, direct exposure to sun rays and direct heat sources (lamps, hot air flow from the unit itself, etc.).
- ▶ If possible, do not place the control system on walls bordering the outside, to avoid false temperature readings and therefore affect system operation. If this is not possible, shield the control system by placing a sheet of insulating material (cork, polystyrene or other similar) between the control system and the wall.



By following the above guidelines, unwanted starting and stopping of the system can be avoided and optimal comfort in the heated space can be guaranteed.

4.4.2 Chronothermostat



How to install the chronothermostat

The chronothermostat must be installed on the wall in a suitable position, using expansion screws.

The chronothermostat is supplied already connected to the electronic board of the gas unit heater by means of a 5-metre long cable (Figure 4.2 p. 22).



For lengths longer than 5 meters use an unshielded 2x0,75 mm² cable with 5 Ω maximum resistance for each conductor (use a shielded cable if the installation has strong electromagnetic interference).



The cable may not be longer than 30 metres.

Figure 4.2 Connection of chronothermostat and dialogue board if the supplied cable is not used

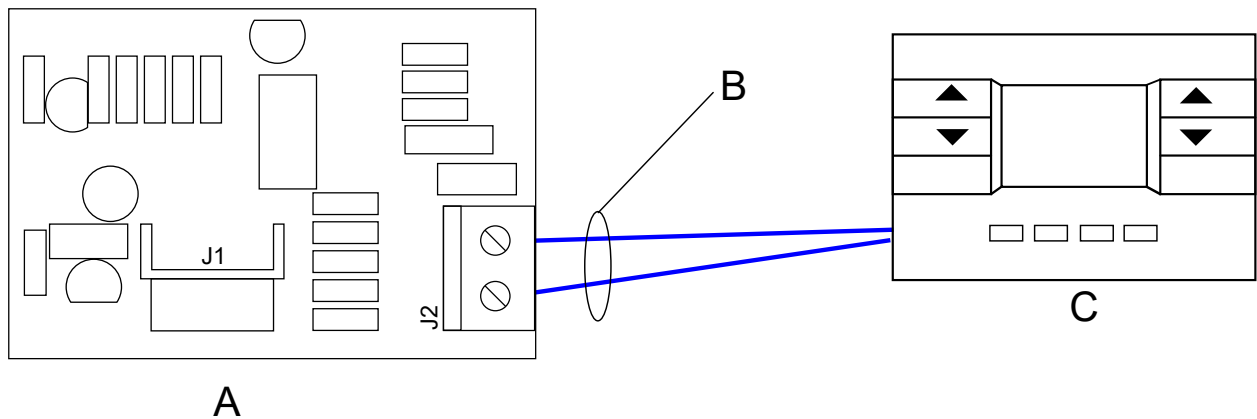

A Dialogue board located on the control board at position X13

B Cable 2x0,75 mm², maximum resistance for conductor 5 Ω, maximum

length 30 meters

C Chronothermostat

4.4.3 Control of multiple gas unit heaters with a single external request

In winter it is possible to control several gas unit heaters with a single external request (e.g. programmable timer) by removing the electrical bridge on the terminals X10 (Paragraph 1.3 p. 10) marked with the radiator symbol  and connecting the external request to the same terminals (Figure 4.3 p. 23).

In summer it is possible to control several gas unit heaters with a single external request (e.g. programmable timer) by removing

the electrical bridge on the terminals X7 (Paragraph 1.3 p. 10) marked with the fan symbol  and connecting the external request to the same terminals (Figure 4.3 p. 23).

In any case, each gas unit heater must be connected to the respective chronothermostat and the operation enable must also be provided by the latter.

Opening the external enable contact will cause the gas unit heater to be switched off regardless of what is foreseen by the chronothermostat.

Figure 4.3 Wiring diagram for controlling multiple gas unit heaters with external enables

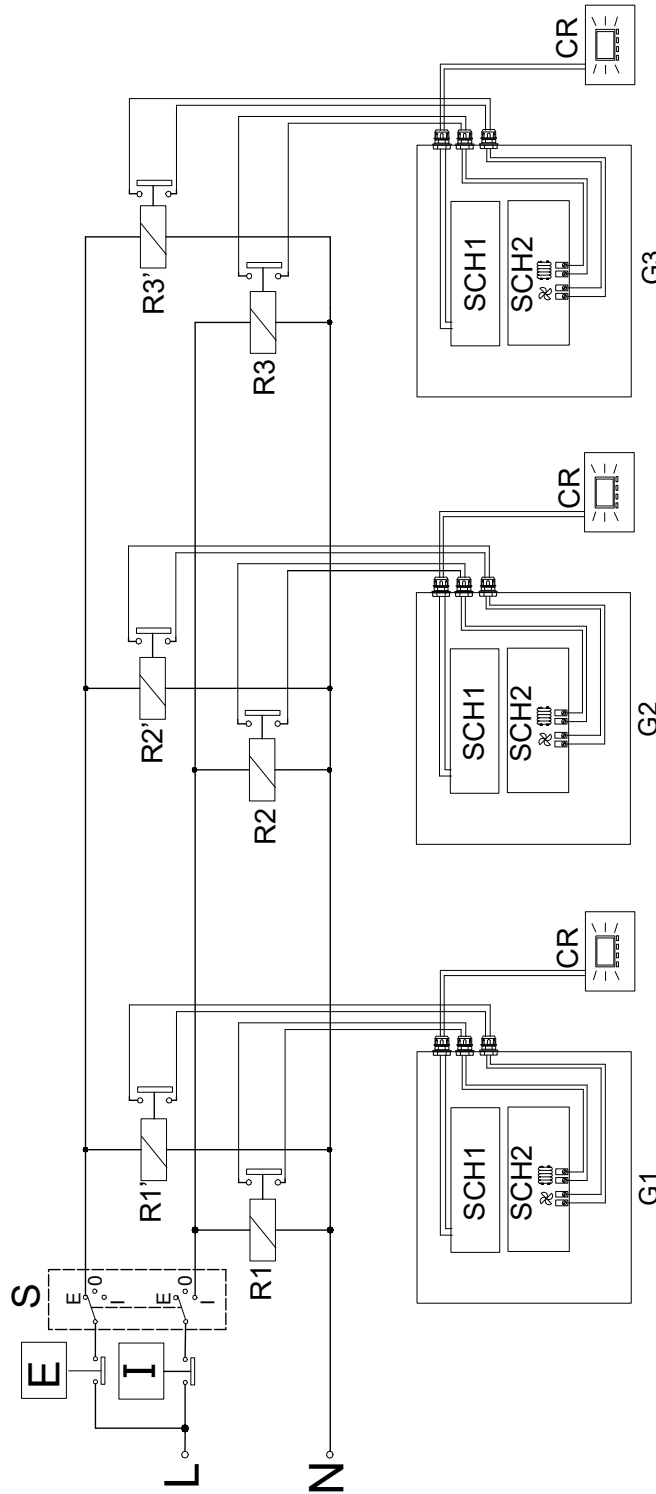

- | | | | |
|--------|---|--|------------------|
| E | Gas unit heaters summer operation enable | SCH1 | Control board |
| I | Gas unit heaters winter operation enable | SCH2 | Motor board |
| R1'-3' | Relay for the winter operation enable of the gas unit heaters | G1-3 | Gas unit heater |
| R1'-3' | Relay for the summer operation enable of the gas unit heaters | CR | Chronothermostat |
| S | Summer/winter selector switch | WARNING: Each gas unit heater must be connected to the respective chronothermostat | |

4.5 REMOTE THE FAULT SIGNALS

Any faults that may occur during normal operation of the gas unit heater can be identified by means of an error code on the chronothermostat display (for further information see Table 6.5 p. 32).

Any fault can also be signalled remotely by connecting a warning light to terminals X9 of the motor board (output 230V - 50Hz, see diagram in Figure 4.4 p. 24).

 The cable may not be longer than 200 metres.

Figure 4.4 Flame lockout lamp connection



When the led comes on, in the manner described in Table 4.1 p. 24, it indicates the presence of a fault.

Table 4.1 Led status to signal faults

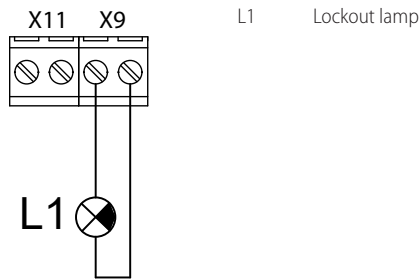
Fault	LED status
Flame lockout	Fixed
Limit thermostat trip or minimum flue gas temperature thermostat trip (1)	Flashing (on = 4 seconds, off = 1 second) (2)
Other type of anomaly	Flashing (on = 1 second, off = 4 seconds) (2)

1 The flue gas temperature thermostat is present on the G series gas unit heaters.
 2 After 72 hours of continuous flashing status, the led becomes fixed.

4.6 REMOTE THE ERROR RESET

Remote unlocking can also be performed. To do this, a button must be connected to terminals X11 of the motor board (230V - 50Hz output, see diagram in Figure 4.5 p. 24). Closing the contact causes the fault to be reset.

Figure 4.5 Flame lockout reset button connection

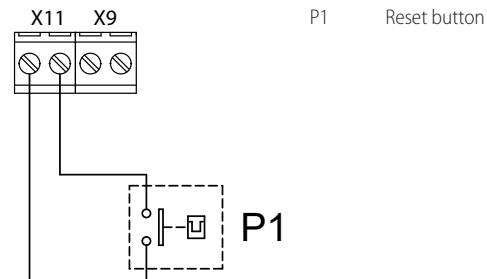

5 FIRST START-UP



First start-up entails checking/setting up the combustion parameters and may exclusively be carried out by a Robur TAC. NEITHER the user NOR the installation technician is authorised to perform such operations, under penalty of voiding the warranty.

The installer is obliged to carry out preliminary checks described in Paragraph 5.1 p. 24.

- ▶ Combustion air feed and flue gas exhaust correctly carried out according to the regulations in force.
- ▶ Power supply mains complying with the appliance's rating plate data.
- ▶ Appliance correctly installed, according to the manufacturer's instructions.
- ▶ System installed in a workmanlike manner, according to national and local regulations.

5.1 PRELIMINARY CHECKS



Paragraph dedicated to the installer.

5.1.1 Preliminary checks for first start-up

Upon completing installation, before contacting the TAC the installer must check:

- ▶ Electrical and gas systems suitable for the required capacities and equipped with all safety and control devices required by the regulations in force.
- ▶ Absence of leaks in the gas system.
- ▶ Type of gas for which the appliance is designed (natural gas, LPG or other gas).
- ▶ Supply gas pressure complying with the values of Table 3.1 p. 15, with max tolerance $\pm 15\%$.
- ▶ Correct operation of the flue exhaust duct.

5.1.2 Abnormal or hazardous installation situations

Should any abnormal or hazardous installation situations be found, the TAC shall not perform first start-up and the appliance shall not be commissioned.

These situations may be:

- ▶ Failed compliance with minimum clearances.
- ▶ Insufficient distance from combustible materials.
- ▶ Conditions that do not warrant access and maintenance in safety.
- ▶ Appliance switched on/off with the main switch, instead of the provided control device.
- ▶ Appliance defects or faults caused during transport or installation.
- ▶ Gas smell.
- ▶ Non-compliant mains gas pressure.
- ▶ Non-compliant flue gas exhaust.
- ▶ All situations that may involve operation abnormalities or are potentially hazardous.

5.1.3 Non-compliant system and corrective actions

Should the TAC find any non conformities, the user/installer is bound to perform any corrective procedures required by the TAC.

After performing the remedial actions (the installer's responsibility), if the TAC deems that safety and conformity conditions are in place, first start-up may be effected.

5.2 COMBUSTION PARAMETERS CHECK



Paragraph reserved exclusively to TACs.



The gas unit heater is supplied with the gas valve already calibrated with respect to the fuel indicated on the sticker next to the gas connection. Therefore, during the commissioning, only the CO₂ value must be checked and, only if the check is not successful, or after a gas changeover, the complete check procedure must be carried out.



The CO₂ value should be checked with the thermoformed door closed, while the gas valve should be adjusted with the thermoformed door open.



If a differential pressure gauge is used, it is necessary to connect the pressure intake A of the gas valve to the + (positive) port of the pressure gauge.



Figure 5.1 p. 25

1. If the appliance is running, switch it off with the applicable control system.
2. Connect a pressure gauge to offset pressure fitting (A), after having first removed or loosed the sealing screw.
3. Turn the appliance on to level 3 (maximum power) and wait for the time necessary to complete the flame stabilisation phase (about 2 minutes).
4. Use the ▼ key on the chronothermostat to set the minimum capacity/flow rate (level 1).
5. Using the IP key, enter the INFO menu and with the OK key select the RPM string and check that the blower speed at level 1 (minimum output) corresponds to the value indicated in Table 5.1 p. 25.
6. Turn the offset adjustment screw until the nominal offset pressure value shown in the following Tables is obtained, with a tolerance of ±1 Pa.
7. Ensure the CO₂ value is between values indicated in column "Minimal heat input" of the following Tables, depending on the model and the gas type used. Otherwise set CO₂ percentage reading by acting on the offset adjustment screw.



Check the burner, which must not have reddened areas.

8. Disconnect the pressure gauge and tighten the sealing screw of the pressure intake (A).
9. Close the door and use the remote control to set level 3 (maximum power/flow rate).
10. Wait for the time necessary to complete the flame stabilisation phase (at least 5 minutes).
11. Ensure the CO₂ value is between values indicated in column "Nominal heat input" of the following Tables, depending on

the model and the gas type used.

If the check is successful:

12. Stop manual forcing of the power level.

If the check is not successful:

13. Repeat steps 3 to 7 (excluding step 6) to reactivate the minimum power operation; check again and, if necessary, correct the CO₂ value in such conditions by actuating the offset adjustment screw.
14. Repeat step 12 to complete the procedure.



Check that the static and dynamic supply gas pressure values, with the gas unit heater running at maximum power, correspond to what is shown in Table 3.1 p. 15 (with low supply gas pressure values the CO₂ value will also be at minimum values).

Table 5.1 Blower speed

Model	Blower speed at level 1 minimum power (rpm)	Blower speed at level 3 maximum power (rpm)
G30	1900	3500 ± 150
G45	1700	4850 ± 150
G60	2000	5650 ± 150
G100	2050	6000 ± 150

Figure 5.1 Gas valve

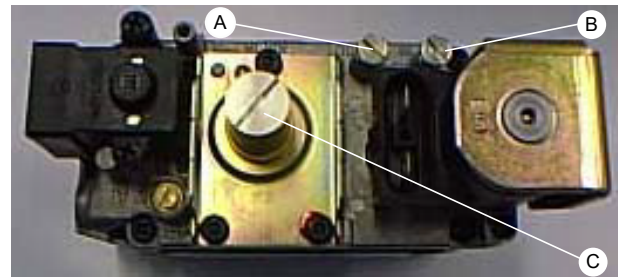

- A Offset pressure intake C Offset adjustment screw
B Gas mains pressure intake

Table 5.2 G30 gas valve setting table

Gas	Gas network pressure	Offset pressure	CO ₂ percentage in fumes	
		nominal	Minimal heat input	Nominal heat input
Type	mbar	Pa	%	%
G20	See Table 3.1 p. 15	-5	8,4	8,8
G25		-5	8,3	8,7
G25.1		-5	9,7	10,3
G25.3		-5	8,4	8,9
G27		-5	8,3	8,8
G2.350		-5	8,3	8,8
G30		-5	9,8	10,2
G31		-5	9,0	9,7
LPG	-5	9,4	9,7	

A tolerance of ±0,3% is applied to all values of CO₂ percentage in fumes.

Table 5.3 G45 gas valve setting table

Gas	Gas network pressure	Offset pressure	CO ₂ percentage in fumes	
			nominal	
Type	mbar	Pa	Minimal heat input	Nominal heat input
G20	See Table 3.1 p. 15	-5	%	%
G25		-5	8,7	9,1
G25.1		-5	8,4	9,0
G25.3		-5	9,9	10,8
G25.3		-5	8,4	9,0
G27		-5	8,6	9,1
G2.350		-5	8,4	9,2
G30		-5	9,8	10,2
G31		-5	9,6	9,8
LPG		-5	9,5	9,9

A tolerance of ±0,3% is applied to all values of CO₂ percentage in fumes.

Table 5.4 G60 gas valve setting table

Gas	Gas network pressure	Offset pressure	CO ₂ percentage in fumes	
			nominal	
Type	mbar	Pa	Minimal heat input	Nominal heat input
G20	See Table 3.1 p. 15	-5	%	%
G25		-5	8,3	8,9
G25.1		-5	8,3	9,1
G25.3		-5	9,8	10,4
G25.3		-5	8,2	8,7
G27		-5	8,5	9,0
G2.350		-5	8,5	9,0
G30		-5	9,7	10,0
G31		-5	9,8	10,4
LPG		-5	9,7	10,1

A tolerance of ±0,3% is applied to all values of CO₂ percentage in fumes.

Table 5.5 G100 gas valve setting table

Gas	Gas network pressure	Offset pressure	CO ₂ percentage in fumes	
			nominal	
Type	mbar	Pa	Minimal heat input	Nominal heat input
G20	See Table 3.1 p. 15	-5	%	%
G25		-5	8,6	9,5
G25.1		-5	8,5	9,4
G25.3		-5	9,8	10,6
G25.3		-5	8,2	9,0
G27		-	-	-
G2.350		-	-	-
G30		-5	10,6	10,9
G31		-5	10,0	10,7
LPG		-5	9,7	10,1

A tolerance of ±0,3% is applied to all values of CO₂ percentage in fumes.

5.3 GAS CHANGEOVER



For gas change instructions, refer to the relevant documentation.

6 NORMAL OPERATION



This section is for the end user.

6.1 WARNINGS



General warnings

Prior to using the appliance carefully read the warnings in Chapter III.1 p. 4, providing important information on regulations and on safety.



First start-up by TAC

First start-up may exclusively be carried out by a Robur TAC (Chapter 5 p. 24).



Never power the appliance off while it is running

NEVER power the appliance off while it is running (except in the event of danger, Chapter III.1 p. 4), since the appliance or system might be damaged.

6.2 SWITCH ON AND OFF



Routine switching on/off

The appliance may exclusively be switched on/off by

means of the suitably provided control device.



Do not switch on/off with the power supply switch

Do not switch the appliance on/off with the power supply switch. This may be harmful and dangerous for the appliance and for the system.



Inspections before switching on

Before switching on the appliance, ensure that:

- gas valve open
- appliance electrical power supply (main switch ON)
- connection and any necessary power supply of the control device



After a long period of unit inactivity or at the first start-up, it may be necessary to repeat the ignition operation due to the presence of air in the gas piping.

6.3 CHRONOTHERMOSTAT

Figure 6.1 Digital chronothermostat

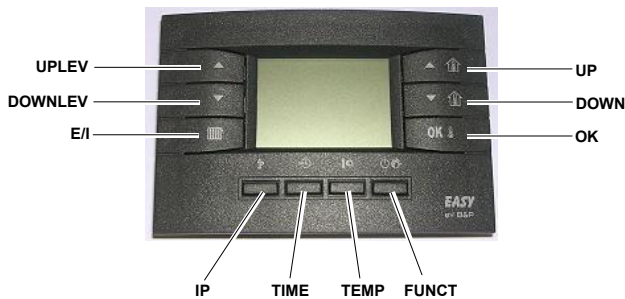

To make the settings described in the following paragraphs, the chronothermostat must be connected to the electrical panel of the gas unit heater and the gas unit heater must be electrically powered.

6.3.1 Functions of the chronothermostat keys

The keys on the chronothermostat have the following functions:

- ▶ UPLEV (▲) and DOWNLEV (▼) keys: allow to modify the level of the heat output/air flow from level 0 to level 3 (level 1 minimum flow rate, level 2 average flow rate, level 3 maximum flow rate; by selecting level 0 during winter operation the flow rate will modulate automatically, by selecting level 0 during summer operation the fan will be turned off).
- ▶ E/I (🌀) key: allows you to select winter (the radiator symbol appears on the display) or summer (the burner is off and only the fan is running) operation.
- ▶ UP (▲↑) and DOWN (▼↑) keys: allow you to change the room setpoint temperature; the increase is 0,1 °C. Keeping one of the two keys pressed results in a faster and continuous change.
- ▶ OK (OK) key: displays the current room temperature, the required room temperature, confirms the set data.
- ▶ IP (⌚) key: to enter the programming mode and to access the INFO menu as specified below:
 - PROG programming mode: briefly press the ⌚ key, the display will show the PROG sliding text for a few seconds; to exit the programming mode, briefly press the ⌚ key again; the display will show the RUN sliding text for a few seconds.
 - INFO menu: press the ⌚ key for at least 3 seconds, the display will show the sliding INFO text for a few seconds; to exit the INFO menu, briefly press the ⌚ key again,

the display will show the sliding RUN text for a few seconds.

- ▶ TIME (⌚) key: allows you to set the timed operations (for more information see Paragraph 6.3.7 p. 29).
- ▶ TEMP (🌡️) key: allows you to select the comfort temperature or the reduced temperature.
- ▶ FUNCT (🔌) key: allows you to set the automatic, manual or off operation. When the off operation is set, the gas unit heater is in standby mode: only the antifreeze function remains active (if it has not been deactivated from the INFO menu - for further information see Paragraph 6.3.9 p. 31).



The functions of the keys described above refer to standard operation. The keys change function depending on the window displayed.

6.3.2 Set the day and time on the chronothermostat

To set the current day and time, proceed as follows:

1. Enter programming mode by shortly pressing the ⌚ key: PROG will appear on the display for a few seconds and then the time and day of the week will appear with the DAY icon on.
2. With the ▲↑ and ▼↑ keys you can change the selected value (which is blinking). To switch between the values, simply press either the OK 🌡️ or the ⌚ key.
3. After having set the current date and time, press the ⌚ key to exit the programming mode, the display will show for a few seconds the RUN sliding text.

6.3.3 Set the comfort, reduced and antifreeze temperatures on the chronothermostat

1. Enter programming mode by shortly pressing the ⌚ key.
2. Press the 🌡️ key repeatedly to select the temperature to be set.
3. On the lower left of the display, COMFR will appear for programming the comfort temperature, ECONM will appear for programming the reduced temperature and OFF°C will appear for programming the antifreeze temperature (Figure 6.2 p. 27).
4. Use the ▲↑ and ▼↑ keys to set the desired temperature.
 - The value of the comfort temperature must be between 5,0 and 30,0 °C (in steps of 0,1 °C).
 - The reduced temperature value must be between 5,0 and 25,0 °C (in steps of 0,1 °C).
 - The value of the antifreeze temperature must be between 2,0 and 10,0 °C (in steps of 0,1 °C).
5. To confirm the set value, press the OK 🌡️ key. This will move you to the next setting.
6. After setting the desired temperatures, press the ⌚ key to exit the programming mode.

Figure 6.2 Comfort, reduced and antifreeze temperatures

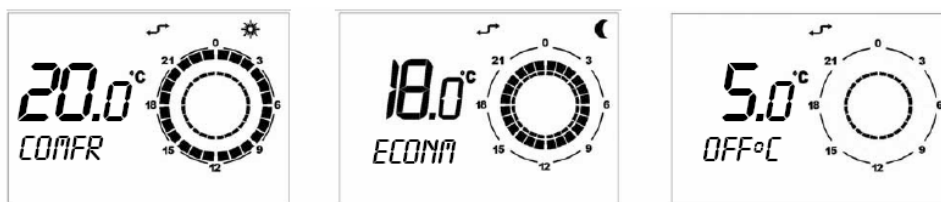

6.3.4 Free programming of daily setpoints on the chronothermostat

1. Enter programming mode by shortly pressing the **P** key.
2. Press the **⏻** key repeatedly.
3. On the lower left of the display, the message SP n will appear, where n indicates the number of the daily setpoint (Figure 6.3 p. 28).

Figure 6.3 Daily setpoint

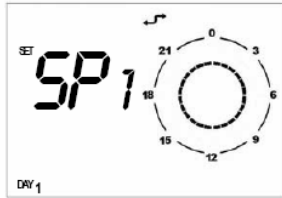

The daily setpoint refers to the time at which the operating setting, i.e. the desired temperature level, changes. The set temperature value remains valid until the next setpoint.

4. Set the desired day of the week using the **DAY** key.
5. Use the **▲** and **▼** keys to select the setpoint to be set.
6. Set the time using the **▲** and **▼** keys (minimum steps of 10 minutes).
7. Set the desired temperature level using the **⊖** key: the sun icon for the comfort setpoint, the moon icon for the reduced setpoint and neither icon for the antifreeze setpoint will appear on the top right of the display.
8. The set time and temperature level will also be displayed on the display clock (see Figure 6.4 p. 28).
9. To move on to the programming of the next setpoint, press the **▲** or **▼** key and set the time and temperature level as previously done: for each daily profile it is possible to set up to 8 setpoints.
10. In the example of Figure 6.4 p. 28 for Monday, 7 setpoints have been set as specified below:
 - Setpoint 1 at 00:00 antifreeze temperature
 - Setpoint 2 at 07:00 econm temperature
 - Setpoint 3 at 08:00 comfr temperature
 - Setpoint 4 at 11:00 econm temperature
 - Setpoint 5 at 14:00 comfr temperature
 - Setpoint 6 at 18:00 econm temperature
 - Setpoint 7 at 19:00 antifreeze temperature

Figure 6.4 Daily setpoint



When freely programming the daily setpoints, it is important to always program all 24 hours as in the example in Figure 6.4 p. 28. If you leave unscheduled time bands, the chronothermostat automatically applies the data set the previous day in those same time bands (even if this is not shown on the display).

In order to simplify the free programming of the daily setpoints, it is possible to associate a preset daily profile to a specific day (Paragraph 6.3.5 p. 28) and then select the same day in free programming mode of the daily setpoints (using the **DAY** key) and proceed to the modification of the daily profile by scrolling with the **▲** and **▼** keys the setpoints and changing the time using the **▲** and **▼** keys, and the temperature level via the **⊖** key.

11. Once the daily profile and its temperature setpoints have been programmed, press the **OK** key to confirm.

Confirming with the **OK** key causes the loss of the daily profile previously set for the same day. Failure to confirm will result in the loss of all settings entered for that daily profile.

12. Press the **P** key to exit the programming mode.

How to check the daily setpoints you have set

1. Enter programming mode by shortly pressing the **P** key.
2. Press the **⏻** key repeatedly.
3. On the lower left of the display, the message SP n will appear, where n indicates the number of the daily setpoint (Figure 6.3 p. 28).
4. Select the desired day of the week using the **DAY** key.
5. Scroll through the setpoints using the **▲** and **▼** keys.
6. Press the **P** key to exit the programming mode.

6.3.5 Choice of a preset daily profile on the chronothermostat

1. Enter programming mode by shortly pressing the **P** key.
2. Press the **⏻** key repeatedly.
3. DAY will appear in the lower left corner of the display.
4. Press the **DAY** key and select the desired day of the week.

Figure 6.5 Daily profile



5. On the top right of the display, the word PROFILE and the number of the selected profile will appear flashing (Figure 6.5 p. 28).
6. By pressing the **▲** and **▼** keys you can select the daily profile from the 16 available (see Table 6.1 p. 29).
7. To confirm press the **OK** key.

Confirming with the **OK** key causes the loss of the daily profile previously set for the same day.

8. Press the **P** key to exit the programming mode.

6.3.6 Choice of a preset weekly profile on the chronothermostat

1. Enter programming mode by shortly pressing the **P** key.
2. Press the **⏻** key repeatedly.
3. WEEK will appear in the lower left corner of the display.

4. On the top right of the display, the word PROFILE and the number of the selected profile will appear flashing (Figure 6.6 p. 29).

Figure 6.6 Weekly profile



5. By pressing the ▲⏮ and ▼⏭ keys you can select the daily

profile from the 16 available (see Table 6.2 p. 29). Each weekly profile is a collection of 7 preset daily profiles.

6. To confirm the selected weekly profile press the **OK**  key.



Confirming with the **OK**  key causes the loss of the weekly profile and the daily profile previously set.



We recommend that you choose the weekly profile that comes closest to your needs and then, for the days when you do not want the daily profile set in the weekly profile, set, as described in the respective paragraph, the desired preset daily profile (see Paragraph 6.3.5 p. 28) or proceed to the free programming of the daily setpoints (see Paragraph 6.3.4 p. 28).

Table 6.1 Daily profiles

Daily profiles	Timetable and temperature level associated with daily setpoints							
	1	2	3	4	5	6	7	8
01	00:00 A	05:30 C	21:30 A	---	---	---	---	---
02	00:00 R	05:30 C	21:30 R	---	---	---	---	---
03	00:00 A	07:00 C	12:00 R	13:00 C	19:30 A	---	---	---
04	00:00 R	07:00 C	12:00 R	13:00 C	19:30 R	---	---	---
05	00:00 R	05:30 C	15:00 R	---	---	---	---	---
06	00:00 A	06:30 C	19:00 A	---	---	---	---	---
07	00:00 A	05:00 R	06:30 C	19:00 R	21:00 A	---	---	---
08	00:00 A	08:00 C	12:00 R	13:00 C	18:00 A	---	---	---
09	00:00 A	04:00 R	07:00 C	18:00 R	21:30 A	---	---	---
10	00:00 A	04:00 R	07:00 C	14:00 R	21:30 A	---	---	---
11	00:00 A	07:00 C	14:30 A	---	---	---	---	---
12	00:00 R	06:00 C	12:00 R	14:00 C	20:00 R	---	---	---
13	00:00 A	05:00 C	12:00 R	13:00 C	21:00 A	---	---	---
14	00:00 C	---	---	---	---	---	---	---
15	00:00 R	---	---	---	---	---	---	---
16	00:00 A	---	---	---	---	---	---	---

A antifreeze temperature
B reduced temperature
C comfort temperature

Table 6.2 Weekly profiles

Weekly profiles	Daily profiles associated with each day of the week						
	Monday	Tuesday	Wednesday	Thursday	Friday	Saturday	Sunday
01	01	01	01	01	01	16	16
02	01	01	01	01	01	01	16
03	06	01	01	01	01	16	16
04	06	01	01	01	01	01	16
05	02	02	02	02	02	16	16
06	02	02	02	02	02	02	16
07	06	02	02	02	02	16	16
08	06	02	02	02	02	02	16
09	01	01	01	01	01	01	01
10	14	14	14	14	14	14	14
11	02	02	02	02	02	02	02
12	06	06	06	06	06	06	06
13	07	07	07	07	07	07	07
14	08	08	08	08	08	08	08
15	09	09	09	09	09	09	09
16	10	10	10	10	10	10	10

6.3.7 Timed functions of the chronothermostat

There are 3 timed operating modes:

- ▶ **Forced automatic** operation: indicated by the presence of both automatic and manual icons (Figure 6.7 p. 30).
- ▶ **Timed off** (holiday program) operation: indicated by the presence of both the hourglass and airplane icons (Figure

6.8 p. 30).

- ▶ **Timed manual** (party) operation: indicated by the presence of both the hourglass and manual icons (Figure 6.9 p. 30).

6.3.7.1 Forced automatic operation

The forced automatic operation allows you to set a different temperature than that provided by the program (for example,

the program provides that the gas unit heater works from 8:00 to 12:00 and the required programmed temperature is 18 °C, but the day is particularly cold and you need the gas unit heater to work until the temperature reaches 20 °C).

To activate forced automatic operation, simply press the ▲⬆ and ▼⬆ keys and set the desired temperature (e.g. 20 °C). The automatic and manual icon will appear on the display (Figure 6.7 p. 30).

The forced automatic operation will last until the next programmed setpoint (in the example until 12:00), at which point the operation will return to being automatic with the setpoint as per the program.

i The forced automatic operation can only be activated when the operation is **automatic** (⏻ key).

Figure 6.7 Forced automatic operation



6.3.7.2 Timed off operation (holiday program)

It allows the gas unit heater to be switched off for a certain period of time; during this period of time, any automatic programmes set are disabled while the antifreeze function remains active (if not deactivated via the INFO menu - Table 6.3 p. 31). Timed off operation is particularly useful when you are away for the holidays.

To activate timed off operation, proceed as follows:

1. Select **automatic** operation with the ⏻ key.
2. Press the DAY key (the display will show the sliding message OFF, the hourglass icon and the aircraft icon).
3. Use the ▲⬆ and ▼⬆ keys to set the duration of the off function. The time can be expressed in:
 - minutes from 10 to 90 (reading MM:nn) (can be increased or decreased in steps of 10 minutes)
 - hours from 2 to 47 (reading HH:nn) (can be increased or decreased in steps of 1 hour)
 - days from 2 to 45 (reading DD:nn) (can be increased or decreased in steps of 1 day)

The passage from minutes to hours and from hours to days is done through a progressive increase of the parameter shown on the screen.
4. During the entire period, the display will show the time remaining until the timed function expires (see Figure 6.8 p. 30).
5. After the timed off period has elapsed, the chronothermostat will proceed with the automatic program.

i You can interrupt the timed function by selecting the **off**, **automatic** or **manual** operation at any time (using the ⏻ key) or by pressing the DAY key again.

Figure 6.8 Timed off operation (holiday program)



6.3.7.3 Timed manual operation (party)

Allows you to set the desired temperature for a certain period of time, at the end of which you switch to the **automatic** operating mode.

To activate timed manual operation, proceed as follows:

1. Select manual operation using the ⏻ key.
2. Use the ▲⬆ and ▼⬆ keys to set the desired temperature.
3. Press the DAY key (the hourglass and hand icons will appear on the display).
4. Use the ▲⬆ and ▼⬆ keys to set the duration of the manual function. The time can be expressed in:
 - minutes from 10 to 90 (reading MM:nn) (can be increased or decreased in steps of 10 minutes)
 - hours from 2 to 47 (reading HH:nn) (can be increased or decreased in steps of 1 hour)
 - days from 2 to 45 (reading DD:nn) (can be increased or decreased in steps of 1 day)

The passage from minutes to hours and from hours to days is done through a progressive increase of the parameter shown on the screen.
5. During the entire period, the display will show the time remaining until the timed function expires (see Figure 6.9 p. 30).
6. After the timed manual period has elapsed, the chronothermostat will proceed with the automatic program.

i You can interrupt the timed function by selecting the **off**, **automatic** or **manual** operation at any time (using the ⏻ key) or by pressing the DAY key again.

Figure 6.9 Timed manual operation (party)



6.3.8 Keypad lock

The chronothermostat can be protected against tampering or unintentional settings by activating the keypad lock function (KEY) as follows:

1. Enter the INFO menu by pressing the IP key for more than 3 seconds: INFO will appear on the display.
2. Press the OK key until the KEY string is displayed.
3. Activate the keypad lock by setting the value 1 using the ▲⬆ and ▼⬆ keys.
4. Press the IP key to exit the INFO menu.
5. After 10 minutes from the last press of any key, the keypad lock function will be activated.



The activation of the keypad lock is visible on the display by means of the "asterisk" symbol that appears by side of the time.

- To reactivate keyboard use, you must press the keys in the following sequence and .
- To deactivate the keypad lock function, repeat the steps 1, 2 and 3, setting the value to 0.

6.3.9 Chronothermostat information window

The INFO menu contains 8 parameters that provide information about the operating mode of the unit; some of these parameters can be modified and allow you to customize the operating mode of the installed unit.

- Enter the INFO menu by pressing the key for more than 3 seconds: INFO will appear on the display.
- Pressing the **OK** key it is possible to display the information windows shown in Table 6.3 p. 31.

Table 6.3 Information windows

Text	Editable parameter	Description	Setting	Default
NF C1	NO	Delivery air temperature display.	-	-
NF C2	NO	Flue gas temperature display.	-	-
SP %	NO	The value, calculated directly by the electronic board, indicates the instantaneous percentage of the modulation range of the power actually delivered by the unit (1).	-	-
SP MX %	YES (3)	This parameter allows you to change the modulation range of the unit to change the maximum limit (maximum heat output delivered by the unit) (1). By setting a value equal to 50%, the gas unit heater will operate from the value 0 to 50% of the modulation range between the maximum (100%) and the minimum expected (0%). It can be particularly useful to set a working percentage of less than 100 when the system is oversized.	from 100% to 0%	100%
RPM	NO	Blower RPM display.	-	-
KEY	YES (3)	Enables or disables the keypad lock of the chronothermostat.	0. lock disabled 1. lock enabled	0
BUILD	YES (3)	Room size parameter. It is recommended to set the value 1 if the room to be heated is small; the value 10 if the room to be heated is large.	from 0 to 10	5
NO FRX	YES (3)	Activates or deactivates the antifreeze function (2).	0. antifreeze disabled 1. antifreeze enabled	1

- To understand the meaning of heat output or modulation percentage, refer to the specific clarification note below.
- The antifreeze function is the function that allows the gas unit heater to be activated if the temperature of the room in which it is installed drops below the set antifreeze temperature (for further details see Paragraph 6.3.3 p. 27). If the value set for the antifreeze temperature is higher than the setpoint value set, it is this value that governs the turning on of the unit.
- To edit use the and/or keys, **OK** key to confirm.



The percentage of heat output is the percentage of the modulation range between the rated and minimum power (see Table 1.2 p. 12). For example, if the SP MX % parameter (maximum limit of the heat output) is set to 50, the modulation range of the gas unit heater will be from 0% to 50%. To know at which heat output the generator will work, it is necessary to perform the following operation (referred to the above example and assuming that the gas unit heater is a G100):

$$\begin{aligned} \text{Maximum modulation range } [(100-0)\%] &= \\ (90,2 \text{ kW} - 33,5 \text{ kW}) &= 56,70 \text{ kW} \\ \text{Modulation heat output} &= \\ (56,70 \text{ kW} \times 50 \%) &= 28,35 \text{ kW} \\ \text{Maximum heat output} &= \\ (33,5 \text{ kW} + 28,35 \text{ kW}) &= 61,85 \text{ kW} \end{aligned}$$

6.3.10 Selection menu window

The selection menu contains 6 parameters that allow you to customize the operating mode of the installed unit.

Table 6.4 Operating parameters

Parameter	Description	Features	Default
PM 01	Operating mode	01 - standard 02 - function not applicable 03 - ventilation priority (only without chronothermostat)	01
PM 02	Ventilation speed in ventilation priority mode (only without chronothermostat)	1. low speed 2. average-low speed 3. average-high speed 4. high speed	4

- Enter the selection menu by pressing the key for 3 seconds and then, after entering the INFO menu, the and keys.
- Use the and keys to scroll through the menu parameters.
- Once the parameter to edit has been defined, scroll through the parameter values with the UP and DOWN keys to proceed with the modification. Once the desired value has been set, it is sufficient to wait (a few seconds) for the value to start flashing. The flashing indicates that the value has been accepted.



If you set a value that is not allowed for the chosen parameter, the default value shown in Table 6.4 p. 31 will be restored.

- Press **OK** to return to the INFO menu.
- Press to exit the INFO menu and return to the main screen.

Parameter	Description	Features	Default
PM 03	Lower modulation depth limit in standard mode. Indicates the lower modulation value of the gas unit heater thermal power (0% corresponds to the minimum power output): e.g.: setting 10% the gas unit heater will modulate from 100% (maximum heat output) to 10% of the modulation range (1).	From 0 to 100%	0%
PM 04	Do not modify		76%
PM 05	Upper modulation depth limit in standard mode. Indicates the upper modulation value of the heat output (100% corresponds to the maximum heat output) of the gas unit heater.	From 0 to 100%	100%
PM 06	Chronothermostat presence	1: with chronothermostat 0: without chronothermostat	1

(1) To understand the meaning of heat output or modulation percentage, refer to the specific clarification note in Paragraph 6.3.9 p. 31.

6.3.11 Fault signals

Any faults that may occur during normal operation of the gas unit heater can be identified by means of an error code on the

chronothermostat display.

Table 6.5 p. 32 shows the descriptions of the faults reported by the chronothermostat, the causes that determine them and the intervention modes.

Table 6.5 Operating faults shown on the chronothermostat

Error code	Fault description	Causes	What to do
01 E (1)	Flame lock-out due to failure to ignite the burner	The ignition electrodes are broken or badly positioned	Check the position or replace electrodes
		The flame sensor is broken or incorrectly positioned or touches the appliance metal structure	Check the position or replace the electrode
		Failure of the electronic board or its electrical connections	Check the electrical connection of the board and replace it if necessary
		Failure of the gas valve or its electrical connections	Check the electrical connection of the gas valve and replace it if necessary
		Ineffective earthing system	Make improvements to the earthing system
		Air in the gas pipes or no gas supply	Purge the air from the gas pipe
02 E (1)	Limit thermostat trip due to overheating of heat exchangers	Dirt accumulation at the air intake	After having identified and resolved the cause of the fault, reset the limit thermostat by pressing the OK  key of the chronothermostat to reset the error
		Obstruction of the delivery outlet	
		Fan failure	
		Sudden power failure of the gas unit heater during its operation	
	Flame fault	Flue gas recirculation in the combustion air duct	Correct the position of the exhaust and intake air terminals or replace them if they are not suitable for use
		Flame sensor fault	Replace the flame sensor electrode
Main electronic board fault		Replace main electronic board	
03 E	Heat exchanger temperature probe fault	Delivery air temperature probe fault	The error message is automatically reset once the triggering fault has been resolved
06 E	Flue probe enable cable interrupted on electronic board	False contact on flue probe enable	Restore the contact
07 E	Failed or incorrect blower operation	Unstable electrical connections	The error message is automatically reset once the triggering fault has been resolved
08 E		Blower motor failure	
09 E		Insufficient blower rotation	Check the electrical connection of the blower and replace it if necessary
10 E	Flue gas temperature probe fault	Flue gas temperature probe fault	Replace the probe
11 E	Lock for minimum flue temperature	Low flue gas temperature	Check that the air intake or flue exhaust ducts are not obstructed or excessively long
			Check that the condensate drain pipe or condensate drain siphon is not obstructed or has an inadequate cross-section
			Check that the flue gas probe is correctly positioned in the flue gas collector

(1) WARNING: after four 01 E and/or 02 E resets within 1 hour, the error can no longer be reset manually; in order to reset the error, you must wait 1 hour or disconnect and reconnect the appliance from the power supply.

Table 6.6 p. 33 shows the faults that may occur during the operation of the gas unit heater but which are not shown on the













chronothermostat.

Table 6.6 Operating faults NOT shown on the chronothermostat

Fault description	Causes	What to do
The burner goes out and does not restart even if the room temperature requires it	The position of the chronothermostat is affected by the influence of heat sources or is affected by the flow of hot air	Check the position of the chronothermostat
	The programming of the chronothermostat has turned off the appliance	Check the programming setting
The chronothermostat is on and the gas unit heater is not working	Power supply to the unit has failed	Check power supply
	Failure of the Interface card with the chronothermostat	Check the electrical connection of the board and replace it if necessary
	The electrical bridge on the electronic board is open	Check that the electrical bridge is closed

6.3.12 Meaning chronothermostat display icons

Table 6.7 Meaning chronothermostat display icons

Icon	Meaning
	Gas unit heater is in standby mode
	Winter operation enabled
	Fault or request for maintenance (see Table 6.5 p. 32)
	Communication between chronothermostat and gas unit heater active
	Comfort temperature in use
	Reduced temperature (Econm) in use
	Automatic operation in use
	Manual operation in use
	Forced automatic operation in use
	Timed off operation in use
	Timed manual operation in use
	Current flame/power level

6.4 GAS UNIT HEATER OPERATING MODES

The gas unit heater has the following usage options (refer to the diagrams in Figure 6.11 p. 36 and Figure 6.10 p. 35).



The gas unit heater must be connected to the electrical and gas networks, with the gas tap open and the bipolar switch in the on position.

6.4.1 Operation with chronothermostat

6.4.1.1 Winter operation (heating)

The heating operation can be (Figure 6.11 p. 36):





- Modulating standard operation

- automatic (unit operation automatically managed by the chronothermostat according to the time schedule)
 - manual (operation of the unit managed manually by the user)
- Fixed standard operation
- automatic (unit operation automatically managed by the chronothermostat according to the time schedule)
 - manual (operation of the unit managed manually by the user)











By default, the gas unit heater leaves the factory configured for the standard operating mode.

6.4.1.2 Modulating automatic standard operation

1. Press the  key of the chronothermostat (Figure 6.1 p. 27) to select the winter operating mode (heating): this operation is identified by the radiator symbol on the chronothermostat display at the top left.
2. Program the day, time, temperatures and weekly and daily profiles of the chronothermostat as specified in the relevant paragraphs.
3. Using the  button of the chronothermostat (Figure 6.1 p. 27) select the type of operation: automatic () (in this mode the operation of the gas unit heater is regulated by the profiles defined by the user).
4. By selecting the flow rate level at 0 ( and  keys), the heat output and the air flow rate will modulate continuously according to an internal algorithm and to the temperature difference between the room setpoint (required temperature) and the detected temperature.





6.4.1.3 Modulating manual standard operation

1. Press the  key of the chronothermostat (Figure 6.1 p. 27) to select the winter operating mode (heating): this operation is identified by the radiator symbol on the chronothermostat display at the top left.
2. Using the  button of the chronothermostat (Figure 6.1 p. 27) select the type of operation: manual () (in this mode the operation of the gas unit heater is managed manually by the user).
3. Use the UP  and DOWN  keys to select the desired room temperature. If you want to use the set temperature, reduced or comfort (Paragraph 6.3.3 p. 27), select the desired setting using the  key.
4. By selecting the flow rate level at 0 ( and  keys), the heat output and the air flow rate will modulate continuously according to an internal algorithm and to the temperature difference between the room setpoint (required temperature) and the detected temperature.



6.4.1.4 Fixed automatic standard operation

1. Press the  key of the chronothermostat (Figure 6.1 p. 27) to select the winter operating mode (heating): this operation is identified by the radiator symbol on the chronothermostat









display at the top left.

2. Program the day, time, temperatures and weekly and daily profiles of the chronothermostat as specified in the relevant paragraphs.
3. Using the  button of the chronothermostat (Figure 6.1 p. 27) select the type of operation: automatic () (in this mode the operation of the gas unit heater is regulated by the profiles defined by the user).
4. By selecting the flow rate level at 1, 2 or 3 ( and  keys), the gas unit heater will have fixed operation at the heat output/flow rate level set (1 = low, 2 = medium, 3 = maximum). The gas unit heater will operate until the required temperature is achieved without any modulation.



Fixed ventilation (with constant ventilation at maximum speed)

1. By selecting the flow rate level at 4 ( and  keys), the air flow rate remains constant at maximum speed and the heat output will modulate continuously according to an internal algorithm and to the temperature difference between the room setpoint (required temperature) and the detected temperature.



6.4.1.5 Fixed manual standard operation

1. Press the  key of the chronothermostat (Figure 6.1 p. 27) to select the winter operating mode (heating): this operation is identified by the radiator symbol on the chronothermostat display at the top left.
2. Using the  button of the chronothermostat (Figure 6.1 p. 27) select the type of operation: manual () (in this mode the operation of the gas unit heater is managed manually by the user).
3. Use the UP  and DOWN  keys to select the desired room temperature. If you want to use the set temperature, reduced or comfort (Paragraph 6.3.3 p. 27), select the desired setting using the  key.
4. By selecting the flow rate level at 1, 2 or 3 ( and  keys), the gas unit heater will have fixed operation at the heat output/flow rate level set (1 = low, 2 = medium, 3 = maximum). The gas unit heater will operate until the required temperature is achieved without any modulation.

Fixed ventilation (with constant ventilation at maximum speed)

1. By selecting the flow rate level at 4 ( and  keys), the air flow rate remains constant at maximum speed and the heat output will modulate continuously according to an internal algorithm and to the temperature difference between the room setpoint (required temperature) and the detected temperature.

6.4.1.6 Switching the appliance off

1. To turn off the gas unit heater, select the off mode by pressing the FUNCT  key: the  icon will appear on the display. This way the gas unit heater is in standby mode: only the antifreeze function remains active, if not deactivated from the INFO menu (see "NO FRX" item of Table 6.3 p. 31).









It is absolutely necessary to avoid, as it is harmful to the appliance, switching it off by disconnecting the electrical power supply, because doing so will cause the immediate shutdown of the fans and the intervention of the limit thermostat, which must be reset manually.

6.4.1.7 Summer mode (ventilation only)

The ventilation only operation can be with manual ventilation or with automatic ventilation (Figure 6.10 p. 35).

1. Close the gas valve and check power supply availability to

the unit.

2. Press the  button on the chronothermostat: radiator symbol will turn off.
3. Using the  and  keys it is possible to choose the ventilation level (level 1 minimum ventilation, level 2 average ventilation, level 3 maximum ventilation). Setting level 0 will not provide ventilation (the fan switches off).
4. During summer operation (ventilation) the burner is switched off and only the fan works by moving the room air. During summer operation, the following ventilation modes can also be selected using the FUNCT  key (Figure 6.10 p. 35):
 - ▶ Fixed manual ventilation (MAN ): continuous ventilation without time limits at the selected ventilation level.
 - ▶ Automatic fixed ventilation (AUTO ): the programmed time slots are used to start the ventilation at the selected level (COMFR), or to stop the ventilation (ECONM).

6.4.2 Operation without chronothermostat

- ▶ Winter operation (heating)
- ▶ Summer mode (ventilation only)
- ▶ Air renewal operation (ventilation priority)









By default, the gas unit heater leaves the factory configured for the standard operating mode with the chronothermostat.

To set a different operating mode (e.g. for air renewal) refer to Paragraph 6.3.10 p. 31.



For further information on the operation and use of the gas unit heater in this mode, please contact the Robur technical service.

6.4.2.1 Winter operation (heating) and summer mode (ventilation only)

1. Enter the selection menu by pressing the  key for 3 seconds and then, after entering the INFO menu, the  and  keys at the same time.
2. Set the parameter PM06 "Chronothermostat presence" to the value 0 (without chronothermostat) (Table 6.4 p. 31).
3. Press **OK**  to return to the INFO menu.
4. Press  to exit the INFO menu and return to the main screen.
5. Disconnect the remote control and remove the dialogue board located on the control board at position X13 (Paragraph 1.3 p. 10).
6. For operation during winter, simply close the X10 contact marked with the  symbol on the SCH2 board. This way the gas unit heater will not operate in modulating mode but in on/off mode with fixed heat output and ventilation (maximum values).
7. For operation during summer (fan operation only) close the contact X7, marked with the  symbol, placed on the SCH2 board. This way the fan will run at maximum speed.
8. To remote the fault signals, refer to the Paragraph 4.5 p. 23.

6.4.2.2 Air renewal operation (ventilation priority)



Air renewal operation is only possible without the chronothermostat.

This gas unit heater operating mode allows on/off operation with ventilation always on and burner ignition only on heat demand (closing of X10 contact).

Ventilation and heat output are fixed (maximum values).

This function is particularly useful if a constant renewal of room air is required.





To set this operating mode, follow the instructions below.

1. Enter the selection menu by pressing the **IP** key for 3 seconds and then, after entering the INFO menu, the **DAY** and **ON/OFF** keys at the same time.
2. Set parameter PM01 "Operating mode" to value 03 (ventilation priority) (Table 6.4 p. 31).
3. Set the parameter PM06 "Chronothermostat presence" to the value 0 (without chronothermostat) (Table 6.4 p. 31).
4. Press **OK** to return to the INFO menu.
5. Press **IP** to exit the INFO menu and return to the main screen.
6. Disconnect the remote control and remove the dialogue board located on the control board at position X13 (Paragraph 1.3 p. 10).



The settings made up to now allow the use of the gas unit heater in two modes: "ventilation only" mode (for

air renewal) or "ventilation with simultaneous heating" mode (for air renewal and heating simultaneously). This setting, therefore, does not allow the gas unit heater to be used in "heating only" mode, granting ventilation priority.

7. To activate the ventilation only mode (fans only operation, for air renewal) close only the contact X7, marked with the  symbol, placed on the SCH2 board. Useful mode, for example, for the summer season.
8. To activate the ventilation mode with simultaneous heating (fan and burner simultaneous operation, for air renewal and simultaneous heating) close, in addition to the contact X7 marked with the  symbol, also the contact X10 marked with the  symbol, both placed on the SCH2 board. To disable the heating request (and turn off the burner only), the X10 contact marked with the  symbol must be opened. Useful mode, for example, for the winter season.
9. To remote the fault signals, refer to the Paragraph 4.5 p. 23.

6.5 OPERATING DIAGRAMS

Figure 6.10 Summer mode

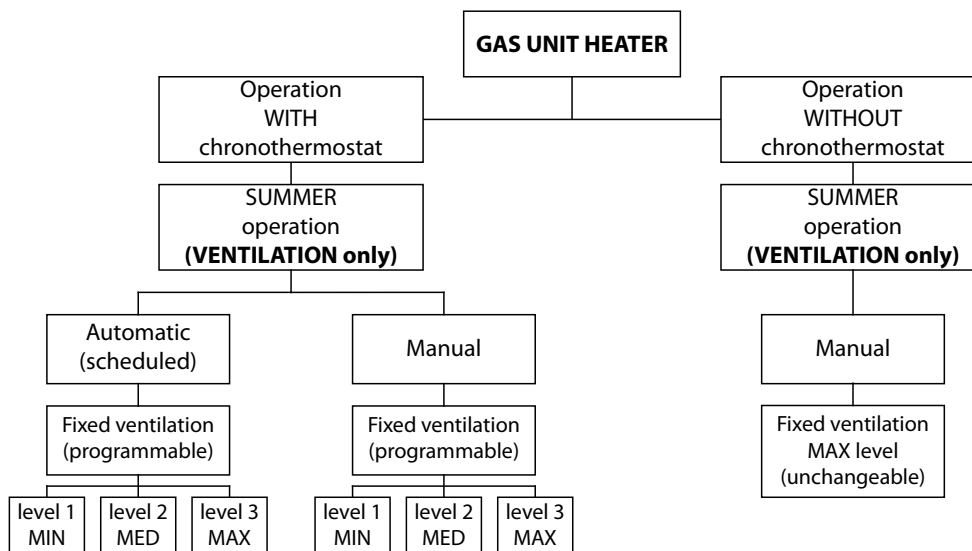
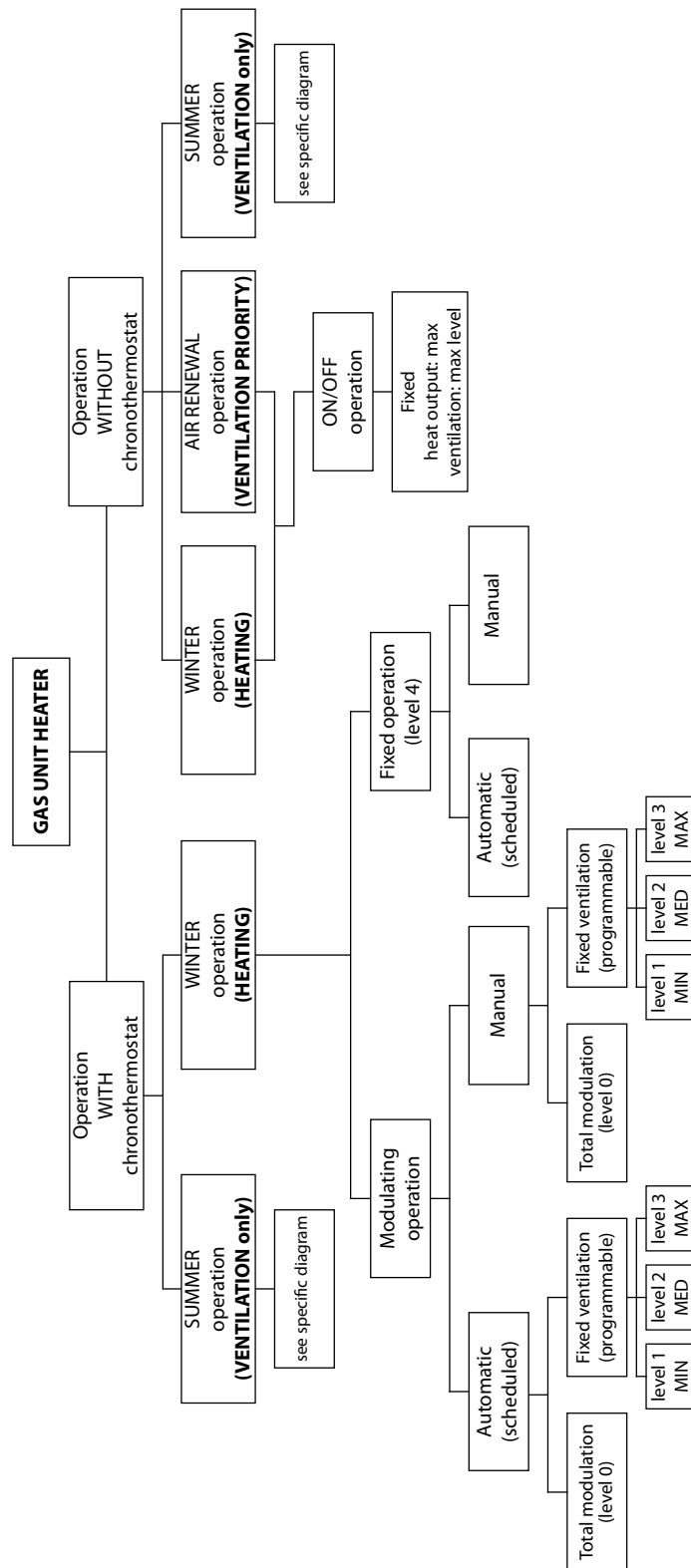

Figure 6.11 Winter operation and air renewal operation



6.6 SETTING RANGE

Through the chronothermostat it is possible to set the heat output of the gas unit heater, setting a value (in percentage) different from the nominal one.

This option modifies the maximum heat output of the gas unit heater accordingly and can be implemented when you want the gas unit heater to have a heat output lower than the nominal

one.



The adjustment of the heat output can only be carried out by a TAC or by professionally qualified personnel.



In case of intervention, the parameter to be modified is PM 05 (Table 6.4 p. 31). For any adjustment, follow the

setting instructions given in Paragraph 6.3.10 p. 31.

The following Table 6.8 p. 37 shows, depending on the model, the values (in percentage) that can be set and the corresponding heat input (to be reported on the nameplate).

Example:

For a G100 gas unit heater, if you want to adjust a heat output of

86,9 kW, you must set (in parameter PM 05) the value 90.



The value of 100 (%) (default value) corresponds to the nominal heat output of the gas unit heater; the value of 0 (%) corresponds to the minimum heat output of the gas unit heater.

Table 6.8 Blower speed and corresponding heat input

PM 05 (upper modulation depth limit)	G30		G45		G60		G100	
	Value to be set [%]	Combustion blower speed [rpm]	Heat input [kW]	Combustion blower speed [rpm]	Heat input [kW]	Combustion blower speed [rpm]	Heat input [kW]	Combustion blower speed [rpm]
100%	3500	30,0	4850	45,0	5650	58,0	6000	93,0
95%	3420	29,3	4693	43,5	5468	56,1	5803	89,9
90%	3340	28,6	4535	42,1	5285	54,3	5605	86,9
85%	3260	27,9	4378	40,6	5103	52,4	5408	83,8
80%	3180	27,3	4220	39,2	4920	50,5	5210	80,8
75%	3100	26,6	4063	37,7	4738	48,6	5013	77,7
70%	3020	25,9	3905	36,2	4555	46,8	4815	74,6



Once the heat input of the heater has been changed, it is mandatory to update the nameplate, showing on it the value of the nominal heat input at the time of

commissioning (EN 1020 and prEN 17082) in indelible letters and in a durable manner.

7 MAINTENANCE

7.1 WARNINGS



Correct maintenance prevents problems, assures efficiency and keeps running costs low.



Maintenance operations described herein may exclusively be performed by the TAC or skilled maintenance technician.



Any operation on internal components may exclusively be performed by the TAC.



Before performing any operation, switch off the appliance by means of the control device and wait for the end of the shutdown cycle, then disconnect power and gas supply, by acting on the electrical disconnect and gas valve.



The efficiency checks and every other "check and maintenance operation" (see Table 7.1 p. 37) must be performed with a frequency according to current regulations or, if more restrictive, according to the provisions set forth by the manufacturer, installer or TAC.



Responsibility for efficiency checks, to be carried out for the aims of restricting energy consumption, lies with the system manager.

7.2 SCHEDULED ROUTINE MAINTENANCE

Perform the operations in the following Table 7.1 p. 37 on an annual basis.

Table 7.1 Scheduled routine maintenance

		R	G	K
Ordinary scheduled maintenance				
Check of the unit	clean the burner	√	√	√
	clean the ignition and flame sensor electrodes	√	√	√
	clean the fan	√	√	√
	clean the blower	√	√	√
	check the % value of CO ₂	√	√	√
	check the unit safety devices	√	√	√
	check that the condensate discharge is clean	-	√	-

7.3 RESETTING THE TEMPERATURE LIMIT THERMOSTAT

The temperature limit thermostat stops the burner in case of appliance overheating.

The reset of the gas unit heater lock by limit thermostat trip is manual and takes place via the remote control.



Resetting of the temperature limit thermostat should be carried out by qualified service personnel, after removing the cause of overheating.



The intervention of the temperature limit thermostat ALWAYS indicates an abnormal condition. Before resetting,

It is therefore advisable to search for the reasons that led to the unit overheating. If frequent stops occur, contact Robur TAC.

7.4 TROUBLESHOOTING

If the gas unit heater does not start in heating mode nor in ventilation, follow the steps below to identify the most likely cause of the fault:

1. Disconnect electrical power supply to the gas unit heater.
2. Check the fuse on the electrical terminal block. If it is broken, replace it with a suitable one (see electrical data in Table 1.2 p. 12).
3. Restore the electrical power supply.
4. Check that the power supply is correct (230 V 1-N 50 Hz).
5. Check gas supply pressure, both static and dynamic, with respect to values in Table 3.1 p. 15.
6. Switch on the gas unit heater via the remote control (presence of the  symbol on the display).
7. Check that the blower starts. If the blower does not start:
 - Check that the limit thermostat has not been triggered. If this is the case, check the overheating cause, remove it, and reset the limit thermostat (procedure Paragraph 7.3 p. 37).
 - Check the presence of voltage at the blower. If the voltage is present but the blower does not start, disconnect blower control cable. If it still does not start, replace the blower condenser. If this also does not solve the problem, replace the blower itself.
8. After 40 seconds from blower start, check the electrodes for sparks. If the electrodes do not spark:
 - Check its position and the connection cable.
 - Check the ignition box fuse. If it is broken, replace it.
 - If the fuse is intact but the electrodes do not spark, replace the ignition transformer.
9. If the burner starts but stops immediately after sparking:
 - Check that the phase and the neutral of the power supply are not reversed.
 - Check the position and integrity of the detection electrode and, if necessary, replace it.
 - If the electrode and power supply are ok, replace the ignition transformer.
10. If the burner does not start or no gas flows from it:
 - Check gas supply.
 - If gas is being supplied, check the gas valve for voltage during sparking. If the correct voltage is applied and the blower is running, check that the nozzle is not obstructed. If the nozzle is free, replace the gas valve.
 - If the gas is still being supplied, but no voltage is supplied to the gas valve, check the electrical connections to the control board and, if correct, replace the control board.
11. After the burner ignition, check that the fan starts (within 120 seconds of ignition of the burner):
 - If it does not start, check the correct operation of the heat exchanger probe and, if necessary, replace it.
 - Check the fan motor condenser and, if necessary, replace it.
 - If this does still not solve the problem, replace the fan motor.

7.5 PERIODS OF INACTIVITY

Should you foresee to leave the appliance inactive for a long period of time, disconnect it from the electrical and gas mains.



How to deactivate the appliance for long periods of time

1. Switch the appliance off (Paragraph 6.2 p. 26).
2. Only when the appliance is completely off, power it off with the main switch/disconnector switch (Detail GS in Figure 4.1 p. 27).
3. Close the gas valve.



The chronothermostat has a 12 hours buffer battery. If the gas unit heater is not electrically powered, after 12 hours, the time and day settings will be lost (the temperature and profile settings will remain however in memory). To avoid this, it is necessary to leave the generator electrically powered even during prolonged periods of inactivity.



How to reactivate the appliance after long periods of inactivity

Before reactivating the appliance, the operator/maintenance technician of the system must first of all:

- Check whether any maintenance operations are required (contact the TAC; see Paragraph 7.2 p. 37).
- Ensure that the flue gas exhaust duct and the air intake are not obstructed.

After completing the above checks:

1. Open the gas valve and ensure there are no leaks; should gas smell be noticed, close the gas valve again, do not switch any electrical devices on and request intervention by qualified personnel.
2. Power on with the main power supply switch (GS, Figure 4.1 p. 27).
3. Switch on the appliance by means of the provided control device (Paragraph 6.2 p. 26).

8 APPENDICES

8.1 PRODUCT FICHE

Figure 8.1

Table 9 Information requirements for warm air heaters							
Model(s): Information to identify the model(s) to which the information relates:							G30
B ₁ warm air heater: [yes/no]							no
C ₂ warm air heater: [yes/no]							no
C ₄ warm air heater: [yes/no]							no
Type of fuel: [gas/liquid/electricity]							gas
Item	Symbol	Value	Unit	Item	Symbol	Value	Unit
Capacity				Useful efficiency			
Rated heating capacity	P _{rated,h}	30,0	kW	Useful efficiency at rated heating capacity (*)	η _{nom}	87,7	%
Minimum capacity	P _{min}	15,0	kW	Useful efficiency at minimum capacity (*)	η _{pl}	94,9	%
Electric power consumption (*)				Other items			
At rated heating capacity	e _{l,max}	0,210	kW	Envelope loss factor	F _{env}	0,0	%
At minimal capacity	e _{l,min}	0,168	kW	Ignition burner power consumption (*)	P _{ign}	0,0	kW
In standby mode	e _{l,sb}	0,000	kW	Emissions of nitrogen oxides (*)	NOx	42	mg/kWh input energy (GCV)
				Emission efficiency	η _{s,flow}	91,8	%
				Seasonal space heating energy efficiency	η _{s,h}	82,9	%
Contact details	Robur SPA Via Parigi 4/6 I-24040 Zingonia (BG)						
(*) Not required for electric warm air heaters.							

Figure 8.2

Table 9 Information requirements for warm air heaters								
Model(s): Information to identify the model(s) to which the information relates:							G45	
B ₁ warm air heater: [yes/no]							no	
C ₂ warm air heater: [yes/no]							no	
C ₄ warm air heater: [yes/no]							no	
Type of fuel: [gas/liquid/electricity]							gas	
Item	Symbol	Value	Unit		Item	Symbol	Value	Unit
Capacity					Useful efficiency			
Rated heating capacity	P _{rated,h}	45,0	kW		Useful efficiency at rated heating capacity (*)	η _{nom}	86,9	%
Minimum capacity	P _{min}	15,0	kW		Useful efficiency at minimum capacity (*)	η _{pl}	94,0	%
Electric power consumption (*)					Other items			
At rated heating capacity	e _{l,max}	0,330	kW		Envelope loss factor	F _{env}	0,0	%
At minimal capacity	e _{l,min}	0,264	kW		Ignition burner power consumption (*)	P _{ign}	0,0	kW
In standby mode	e _{l,sb}	0,000	kW		Emissions of nitrogen oxides (*)	NOx	42	mg/kWh input energy (GCV)
					Emission efficiency	η _{s,flow}	93,7	%
					Seasonal space heating energy efficiency	η _{s,h}	86,1	%
Contact details	Robur SPA Via Parigi 4/6 I-24040 Zingonia (BG)							
(*) Not required for electric warm air heaters.								

Figure 8.3

Table 9 Information requirements for warm air heaters								
Model(s): Information to identify the model(s) to which the information relates:							G60	
B ₁ warm air heater: [yes/no]							no	
C ₂ warm air heater: [yes/no]							no	
C ₄ warm air heater: [yes/no]							no	
Type of fuel: [gas/liquid/electricity]							gas	
Item	Symbol	Value	Unit		Item	Symbol	Value	Unit
Capacity					Useful efficiency			
Rated heating capacity	P _{rated,h}	58,0	kW		Useful efficiency at rated heating capacity (*)	η _{nom}	87,4	%
Minimum capacity	P _{min}	19,3	kW		Useful efficiency at minimum capacity (*)	η _{pl}	94,2	%
Electric power consumption (*)					Other items			
At rated heating capacity	e _{l,max}	0,580	kW		Envelope loss factor	F _{env}	0,0	%
At minimal capacity	e _{l,min}	0,464	kW		Ignition burner power consumption (*)	P _{ign}	0,0	kW
In standby mode	e _{l,sb}	0,000	kW		Emissions of nitrogen oxides (*)	NOx	27	mg/kWh input energy (GCV)
					Emission efficiency	η _{s,flow}	94,1	%
					Seasonal space heating energy efficiency	η _{s,h}	86,1	%
Contact details	Robur SPA Via Parigi 4/6 I-24040 Zingonia (BG)							
(*) Not required for electric warm air heaters.								

Figure 8.4

Table 9 Information requirements for warm air heaters								
Model(s): Information to identify the model(s) to which the information relates:							G100	
B ₁ warm air heater: [yes/no]							no	
C ₂ warm air heater: [yes/no]							no	
C ₄ warm air heater: [yes/no]							no	
Type of fuel: [gas/liquid/electricity]							gas	
Item	Symbol	Value	Unit		Item	Symbol	Value	Unit
Capacity					Useful efficiency			
Rated heating capacity	P _{rated,h}	93,0	kW		Useful efficiency at rated heating capacity (*)	η _{nom}	87,4	%
Minimum capacity	P _{min}	31,7	kW		Useful efficiency at minimum capacity (*)	η _{pl}	95,2	%
Electric power consumption (*)					Other items			
At rated heating capacity	e _{l,max}	1,000	kW		Envelope loss factor	F _{env}	0,0	%
At minimal capacity	e _{l,min}	0,800	kW		Ignition burner power consumption (*)	P _{ign}	0,0	kW
In standby mode	e _{l,sb}	0,000	kW		Emissions of nitrogen oxides (*)	NOx	42	mg/kWh input energy (GCV)
					Emission efficiency	η _{s,flow}	92,9	%
					Seasonal space heating energy efficiency	η _{s,h}	85,5	%
Contact details	Robur SPA Via Parigi 4/6 I-24040 Zingonia (BG)							
(*) Not required for electric warm air heaters.								

Robur mission

Robur is dedicated to dynamic progression in research, development and promotion of safe, environmentally-friendly, energy-efficiency products, through the commitment and caring of its employees and partners.



Robur S.p.A.
advanced technologies
for climate conditioning
via Parigi 4/6
24040 Verdellino/Zingonia (BG) Italy
+39 035 888111 - F +39 035 884165
www.robur.it robur@robur.it

