

Description and application

Ventilation grille for intake and exhaust to spiro ducts. The front frame is shaped according to the channel diameter. Application in low- and medium pressure installations. Recommended is installation in ducts and ventilation openings holes using visible bolts in holes the front frame. The front frame is made of steel profiles. Blades are mounted horizontally (STS-W). Adjusting the angle inclination of blade is manual and individual for each blade. STS-W/G is equipped with a damper (standard - cantilevered damper).

Grille has Hygienic Certificate HK/K/0522/02/2016

Material and workmanship

Material:

- galvanized steel powder coated - RAL 9006 standard
- aluminum powder coated
- stainless steel (type 1.4301 or 1.4404)

On request, it is possible to powder coated in any color RAL palette.

Size

Grilles are manufactured to order. Grilles dimension by the customer request - adapted to the existing spiro duct.

The minimum duct diameter for spiro grilles is 160mm.

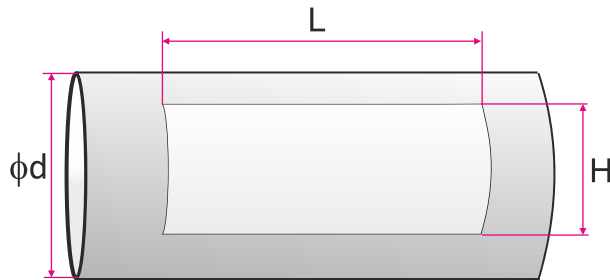

Holes in the frame to screw grille to the channel

L,H - dimensions of the grille mounting hole

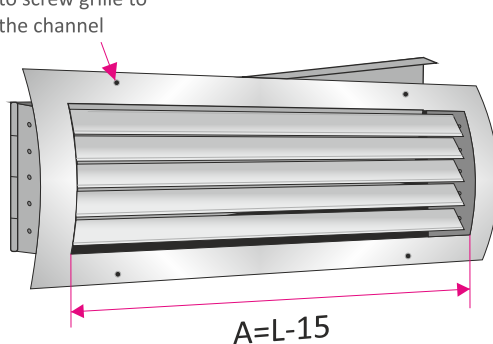

cantilevered damper GU

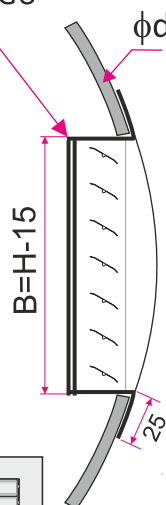

For L>600 the grille is divided (extra stiffened)

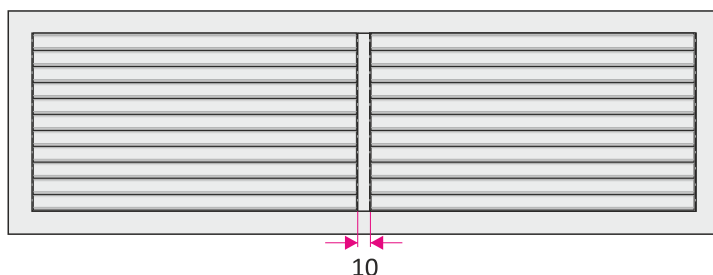

L	H	A _{ef} (m ²)	minimum diameter of the duct ϕd
225	75	0,010	160
325	75	0,015	160
425	75	0,020	160
525	75	0,023	160
625	75	0,028	160
825	75	0,037	160
1025	75	0,046	160
1225	75	0,055	160
125	125	0,010	200
225	125	0,018	200
325	125	0,027	200
425	125	0,035	200
525	125	0,041	200
625	125	0,049	200
825	125	0,066	200
1025	125	0,083	200
1225	125	0,099	200
225	225	0,034	315
325	225	0,049	315
425	225	0,065	315
525	225	0,076	315
625	225	0,092	315
825	225	0,124	315
1025	225	0,156	315
1225	225	0,188	315
325	325	0,072	500
425	325	0,096	500
525	325	0,112	500
625	325	0,135	500
825	325	0,182	500
1025	325	0,229	500
1225	325	0,280	500
425	425	0,130	630
525	425	0,148	630
625	425	0,179	630
825	425	0,240	630
1025	425	0,302	630
1225	425	0,364	630
525	525	0,183	800
625	525	0,222	800
825	525	0,298	800
1025	525	0,375	800
1225	525	0,452	800
625	625	0,265	1000
825	625	0,357	1000
1025	625	0,448	1000
1225	625	0,540	1000

TECHNICAL DATA

The dependence of pressure drop ($\Delta p_{..}$), maximum speed of air stream (V_{ef}), acoustic power level (L_{WA}) and the range air stream of speed $V=0,25$ m/s ($L_{0,25}$) of air volume flow (Q) with grilles at open dampers. Velocity V_{ef} means maximum speed of air outflow measured at the outlet the grille. Range $L_{0,25}$ refers to the distance at which the air speed does not exceed 0,25 m/s.

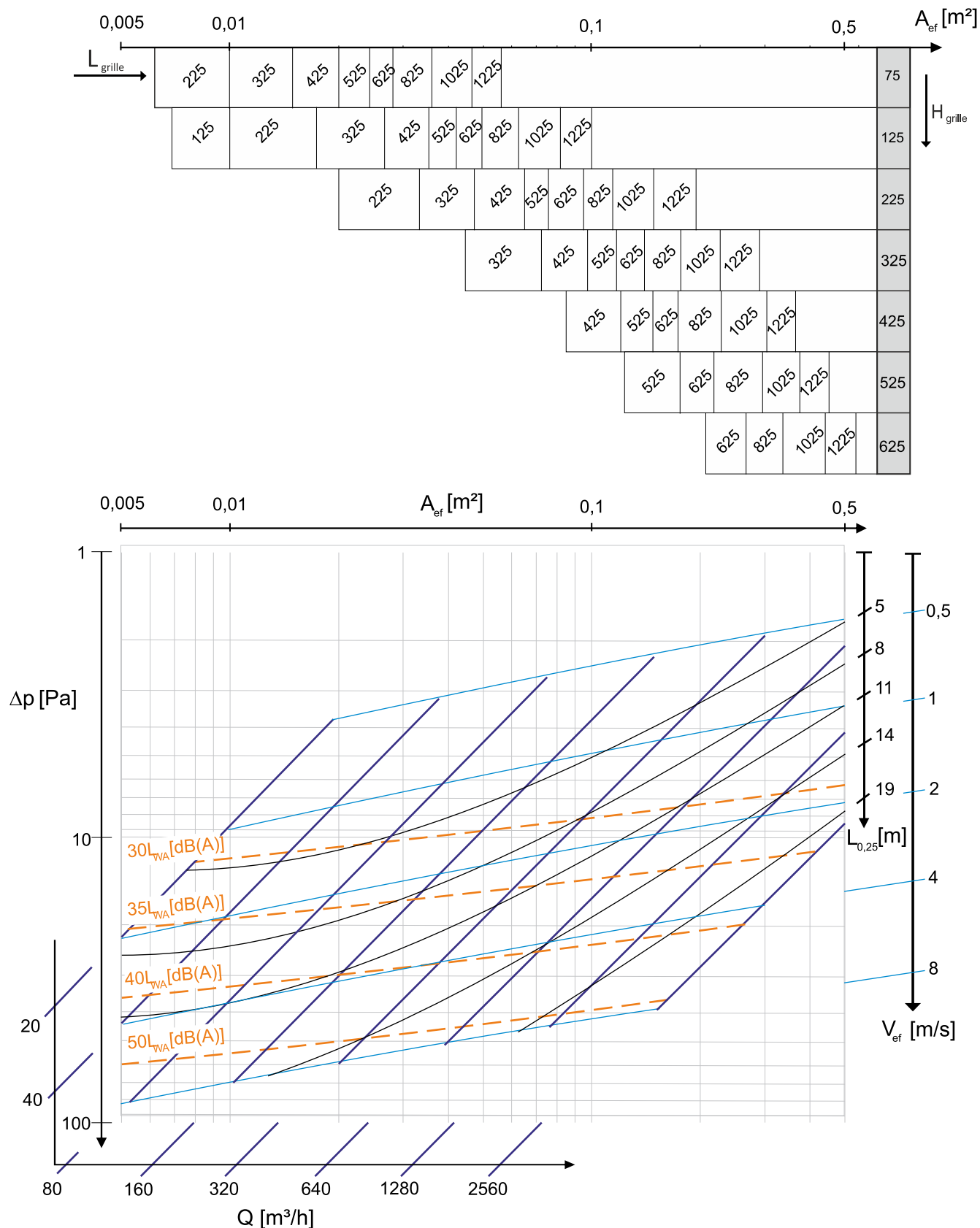

EXAMPLE

- specified air volume flow $Q=400 \text{ m}^3/\text{h}$
- range $L_{0,25}=8 \text{ m}$

Reading from the graph:

- suitable grille: 1025x225, 625x325, 425x425
- $A_{\text{ef}} = 0,13 \text{ m}^2$
- pressure drop: 7 Pa
- effective speed at the outlet: 1,6 m/s
- acoustic power <30 dB

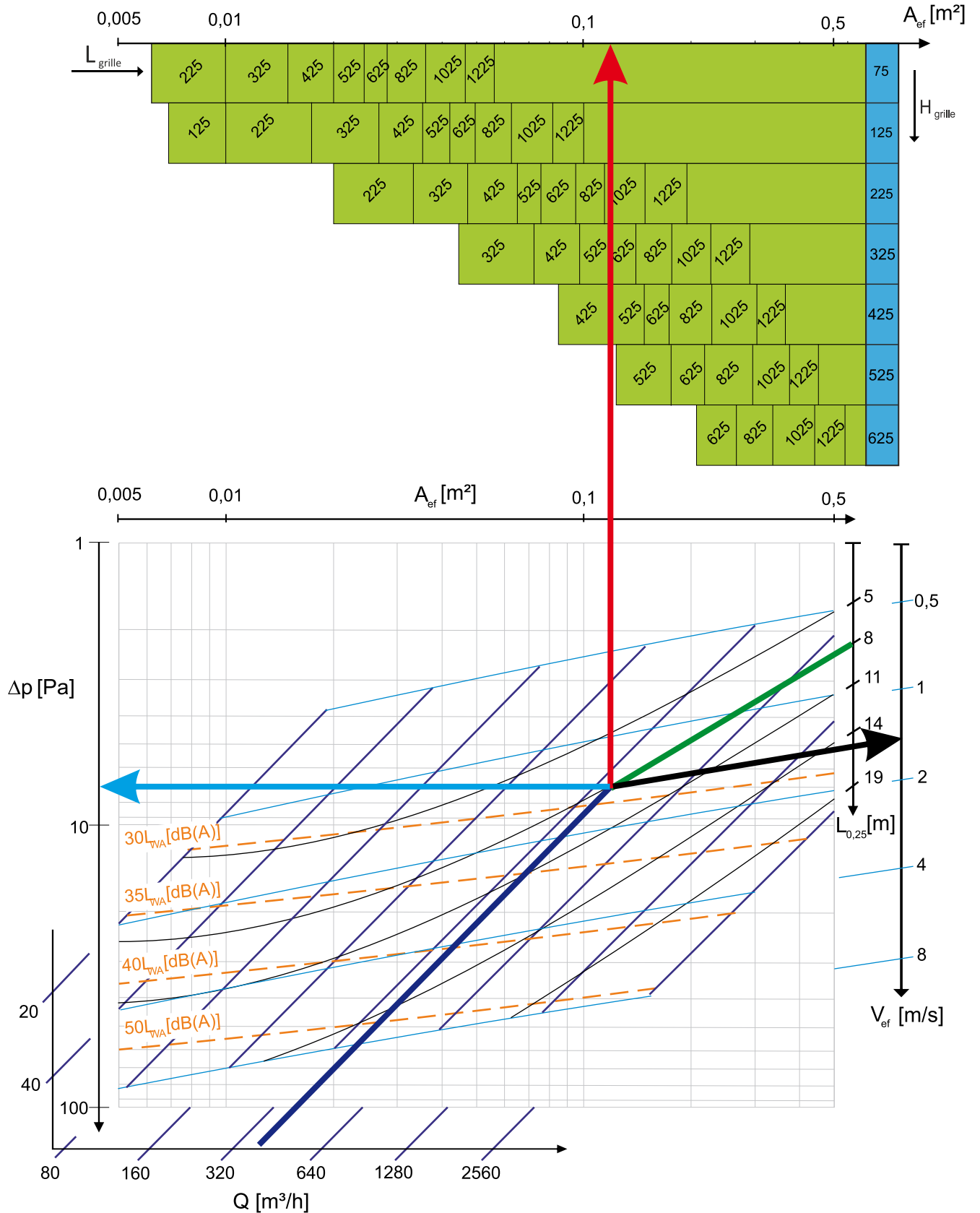

Accessories- dampers

Grille STS-W/G is equipped with a damper, positioned directly behind the grille blades. In this type of grille damper control is from the front side of grille without need to disassembly, by the deflection of grille blades. Below there are the types of dampers used for the ventilation grilles (standard - cantilevered damper).

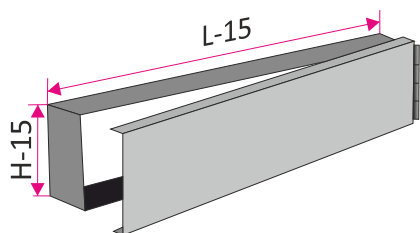

GU - cantilevered damper
(especially recommended for grilles to spiro channel)

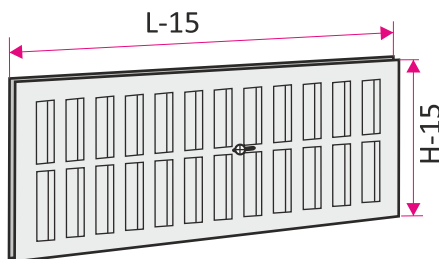

GS - slot damper
(above the size of 525x425 the damper must be divided)

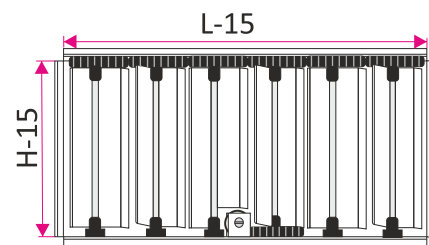

GP - damper with counter running blades
(above the size of 525x425 the damper must be divided)

The method of placing an order

Please make orders according to the following formula:

STS-W/'G' / 'LxH' / 'Dn' / 'W' / 'RAL'

'G'	- damper type: GP - damper with counter running blades GS - slot damper GU - cantilevered damper*
'LxH'	- mounting hole size (width x height) in mm
'Dn'	- the spiro channel diameter (160, 200, 250, 315...)
'W'	- made of: OC - powder coated steel (standard RAL 9006)* AL - aluminum powder coated KO - stainless steel / acid proof steel (type 1.4301 or 1.4404)
'RAL'	- grille color according to RAL palette

* - If you don't give the information will be used standard parameters.